

ICOM

INSTRUCTION MANUAL

UHF FM TRANSCEIVER

IC-4SRA IC-4SRE

Icom Inc.

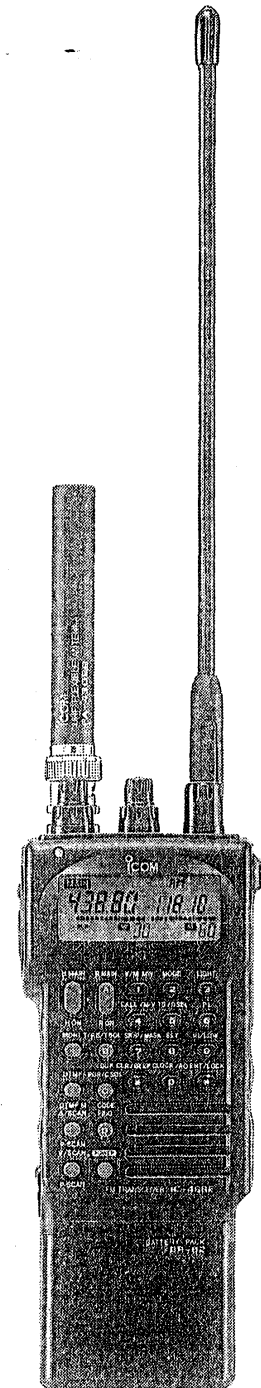

The photo shows IC-4SRE with BP-82 BATTERY PACK. The Battery pack differ according to versions.

IMPORTANT

READ ALL INSTRUCTIONS carefully and completely before using the transceiver.

SAVE THIS INSTRUCTION MANUAL — This instruction manual contains important safety and operating instructions for the IC-4SRA/E.

EXPLICIT DEFINITIONS

The following explicit definitions apply to this manual.

WORD	DEFINITION
CAUTION	Equipment damage may occur.
NOTE	If disregarded, inconvenience only. No personal injury, risk of fire or electric shock.

Some procedures and functions apply to both bands. Look for one these symbols before the title of each section.

SYMBOL	USE
■	For both the ham and receiver bands.
□	Only for the ham band.
◻	Only for the receiver band.

CAUTIONS

NEVER connect the transceiver to an AC outlet or to a power source of more than 16 V DC. These connections will ruin the transceiver.

NEVER connect the transceiver to a power source using reverse polarity. This connection will ruin the transceiver.

NEVER allow children to touch the transceiver.

AVOID using or placing the transceiver in areas with temperatures below -10°C ($+14^{\circ}\text{F}$) or above $+60^{\circ}\text{C}$ ($+140^{\circ}\text{F}$).

AVOID placing the transceiver in direct sunlight.

AVOID the use of chemical agents such as benzine or alcohol when cleaning, as they can damage the transceiver surfaces.

BE CAREFUL! When transmitting for a long time with high output power, the rear panel may become hot.

The use of non-Icom battery packs/chargers may impair transceiver performance and invalidate the warranty.

TABLE OF CONTENTS

IMPORTANT	i	8 CALL CHANNEL.....	23 ~ 24	14 CLOCK AND TIMER.....	40 ~ 44
EXPLICIT DEFINITIONS	i	■ General description.....	23	■ Clock mode	40
CAUTIONS	i	■ Calling up a call channel.....	23	■ Clock operation.....	41
TABLE OF CONTENTS	ii	■ Programming.....	24	■ Power-on timer	42
FOREWORD	1	■ Transferring contents to VFO.....	24	■ Power-off timer	43
OPERATING NOTES.....	1	9 MEMORY MODE.....	25 ~ 28	15 DTMF MEMORY	45 ~ 46
UNPACKING.....	1	■ General description.....	25	<input type="checkbox"/> General description.....	45
1 BASIC OPERATION	2 ~ 4	■ Selecting a memory channel.....	25	<input type="checkbox"/> Transmitting a DTMF code	45
2 PANEL DESCRIPTION	5 ~ 10	■ Programming.....	26	<input type="checkbox"/> Programming a DTMF code.....	46
■ Controls and switches	5	■ Transferring contents to VFO.....	27	16 POWER SAVER.....	47 ~ 48
■ Front panel.....	7	■ Masking a memory channel.....	28	■ Power saver.....	47
■ Function display	9	10 SET MODE	29 ~ 30	■ Auto power-off	47
3 BATTERY PACK CHARGING.....	11 ~ 12	11 REPEATER OPERATION	31 ~ 32	■ Display lighting	48
4 ACCESSORY ATTACHMENT.....	13 ~ 14	<input type="checkbox"/> Operation.....	31	■ One-band operation	48
5 MODE CONSTRUCTION	15 ~ 16	<input type="checkbox"/> Tone information.....	31	■ Beep tone	48
■ Mode types.....	15	<input type="checkbox"/> Offset frequency	32	17 PAGER AND CODE SQUELCH ...	49 ~ 55
■ Changing modes	16	■ Subaudible tone.....	32	■ General description.....	49
6 FREQUENCY SETTING	17 ~ 21	12 SCAN.....	33 ~ 38	■ Code channel	51
■ Selecting VFO mode.....	17	■ Scan type	33	<input type="checkbox"/> Pager operation	53
<input type="checkbox"/> Selecting receive mode	17	■ Scan operations.....	34	■ Code squelch operation.....	55
■ Setting a frequency	18	■ Scan resume condition	35	18 POCKET BEEP AND	
■ Tuning step	21	■ Programming scan edges	36	 TONE SQUELCH	56 ~ 58
■ Dial select step.....	21	■ Frequency skip function.....	37	■ General description.....	56
7 TRANSMITTING.....	22	■ Setting a skip memory channel...	38	■ UT-63 installation.....	57
<input type="checkbox"/> Transmitting.....	22	13 PRIORITY WATCH.....	39	■ Pocket beep operation	58
<input type="checkbox"/> Low output power level.....	22	■ Priority watch types	39	■ Tone squelch operation	58
<input type="checkbox"/> PTT lock.....	22	■ Operation.....	39	19 TROUBLESHOOTING	59
				20 SPECIFICATIONS	60

FOREWORD

Thank you for purchasing the **IC-4SRA/E UHF FM TRANSCIVER**. The IC-4SRA/E is a state-of-the-art handheld consisting of a 430 (440) MHz transceiver and 50~900 MHz wideband receiver, fitting comfortably in the palm of your hand and combining ease of use with multi-operational capability.

OPERATING NOTES

Information overheard but not intended for you cannot lawfully be used in any way.

The IC-4SRA/E may receive its own oscillated frequency, resulting in no reception or only noise reception on some frequencies.

The IC-4SRA/E may receive interference when receiving excessively strong signals on different frequencies.

When the connected battery becomes empty during operation, the transceiver starts emitting beeps to inform you. The transceiver power then cannot be turned OFF until the battery is charged.

UNPACKING

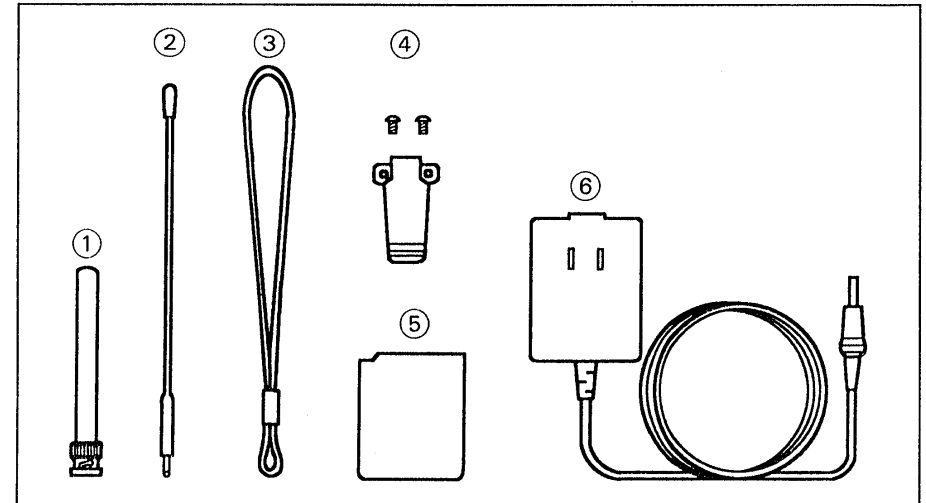

Accessories included with the IC-4SRA/E:	Qty.
① Ham antenna (FA-430BB)	1
② Receiver antenna	1
③ Handstrap	1
④ Belt clip and screws	1 set
⑤ Battery pack or battery case* ¹	1
⑥ Wall charger* ²	1

*¹ Either BP-82, BP-84 or BP-90 will be attached to the transceiver depending on the version.

*² Not included in versions which are attached to the battery case, BP-90.

1 Charge the battery pack

The supplied battery pack may require a full charge prior to operation.

NOTE: If your transceiver includes the battery case instead of the battery pack, remove the battery case and put in dry cell or NiCd batteries. (See p.14 for details.)

- **NEVER** charge a battery case with dry cell batteries.

Turn the transceiver power OFF; then, connect the supplied wall charger as described in the diagrams below.

- See p. 11 for details on safety and use of a desktop charger.

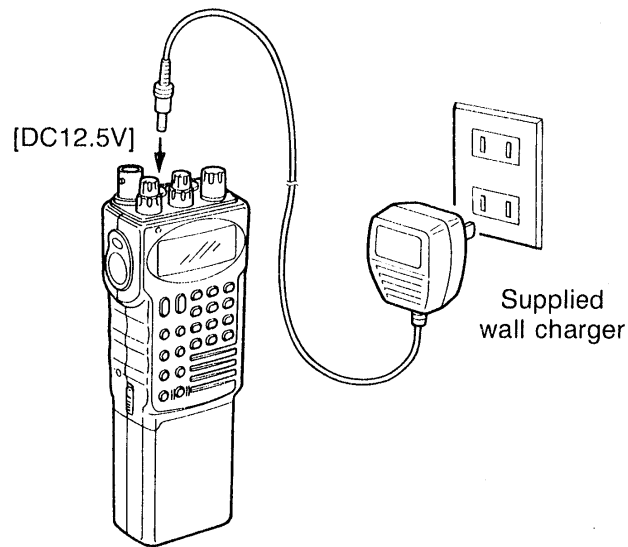

Charging period: approx. 15 hrs.

2 Reset the transceiver

When first applying power, the transceiver may require CPU resetting.

CAUTION: Resetting the CPU will clear and initialize all memory channel contents, SET mode settings, DTMF memory contents and clock and timer settings.

While holding the [F], [R MAIN] and [* CLR] keys, push [POWER] for 1 sec. to turn power ON.

- The function display shows as follows:

The U.S.A. version

440.00, 144.00 MHz

Other versions

430.00, 144.00 MHz

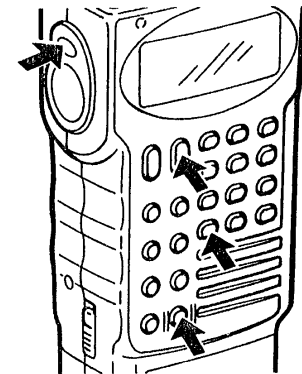

3 Connect the antennas

Connect the 2 supplied antennas.

- The receiver antenna is not always necessary. Connect this antenna in order to use the wideband receiver.

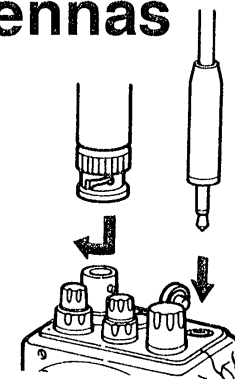

1 BASIC OPERATION

4 Turn power ON

Push and hold the [POWER] key for 1 sec. to turn power ON.

- A beep sounds at power ON.

To turn power OFF, push and hold the [POWER] key for 1 sec. again.

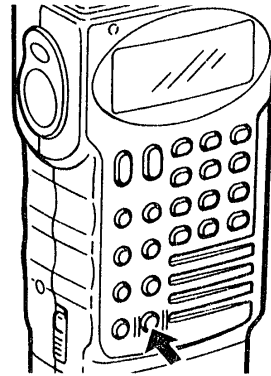

5 Adjust the audio level

HAM BAND AUDIO

- 1) Rotate the HAM [SQL] max. counterclockwise.
- 2) Set HAM [VOL] to the desired level.
- 3) Set HAM [SQL] to mute the audio noise while no signal is received.

RECEIVER BAND AUDIO

Set the RX [VOL] and the RX [SQL] in the same way as the ham band's audio settings.

- When not in use, one-band operation is available. (p. 48)

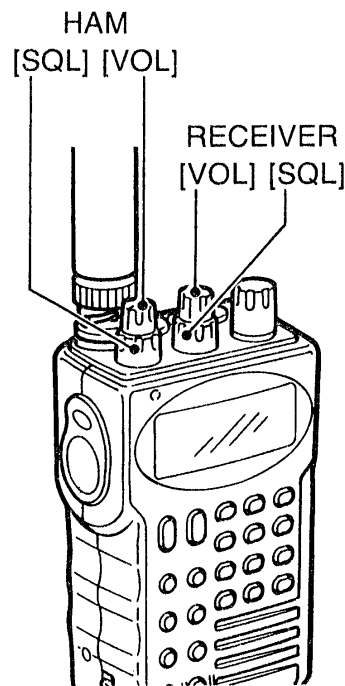

6 Set the frequency

• Using the main dial

- 1) Push [H MAIN] or [R MAIN] to select the desired band as the main band.
 - “MAIN” shows the main band.
- 2) Rotate the main dial to set the frequency.
 - For fast tuning, rotate the main dial while pushing [F].

• Direct frequency input

- 1) Push [H MAIN] or [R MAIN] to select the desired band as the main band.
- 2) Push [# ENT].
- 3) Push the appropriate keys (4~6 digits) to input a frequency.
 - “0” is acceptable for the 1 kHz digit (last digit).

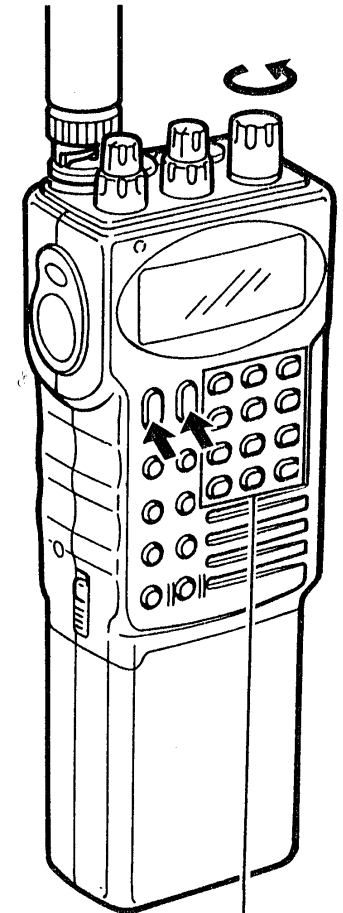

For direct frequency input

See pgs. 18~20 for details.

7 Receive a signal

The transceiver can receive signals on the ham band and receiver band simultaneously. On the receiver band, the receive mode must be selected correctly.

RECEIVE MODE SELECTION

Push [R MAIN], then push [MODE] several times to select the desired receive mode.

- If the selected mode is improper for the receive signal, the audio may be distorted or inaudible.

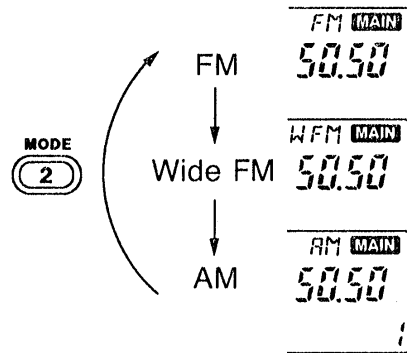

When receiving a signal, the transceiver functions as follows:

- Emits received signal(s) from the speaker.
- Indicates the relative signal strength on the received band S-indicator on the function display.

NOTE: When a [SQL] control is set too "tight" (extremely clockwise), squelch may not open for weak signals. At this time, set the squelch to a "loose" (less clockwise) position, or push and hold the [MONI] key.

8 Transmit a signal

The transceiver transmits only on the ham band; it cannot transmit on the receiver band.

- 1) Push [9 HI/LOW] to select high or low output power.
 - "LOW" appears when low power is selected.
- 2) Push and hold [PTT] to transmit.
 - The LED indicator on the front panel lights up in red while transmitting.
- 3) Speak into the microphone.
 - DO NOT hold the transceiver too closely to your mouth or speak too loudly. This may distort the signal.
- 4) Release [PTT] to receive.

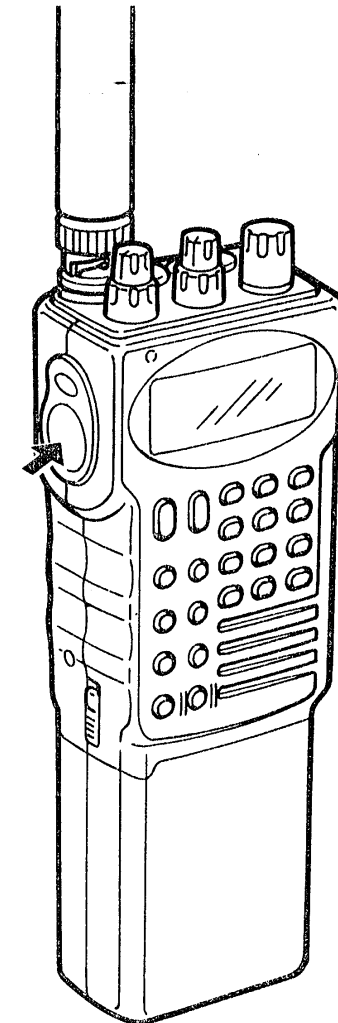

2

PANEL DESCRIPTION

■ Controls and switches

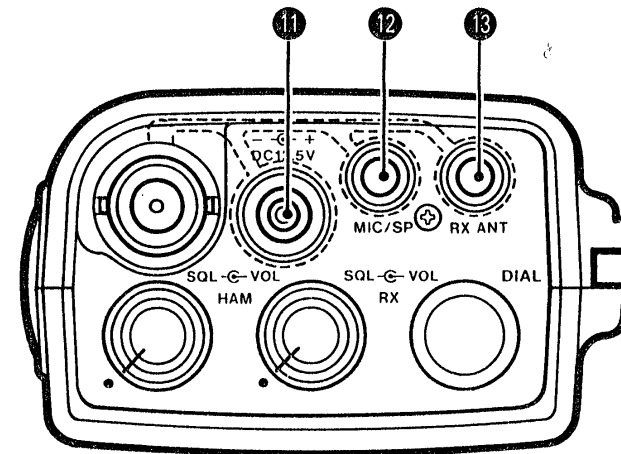
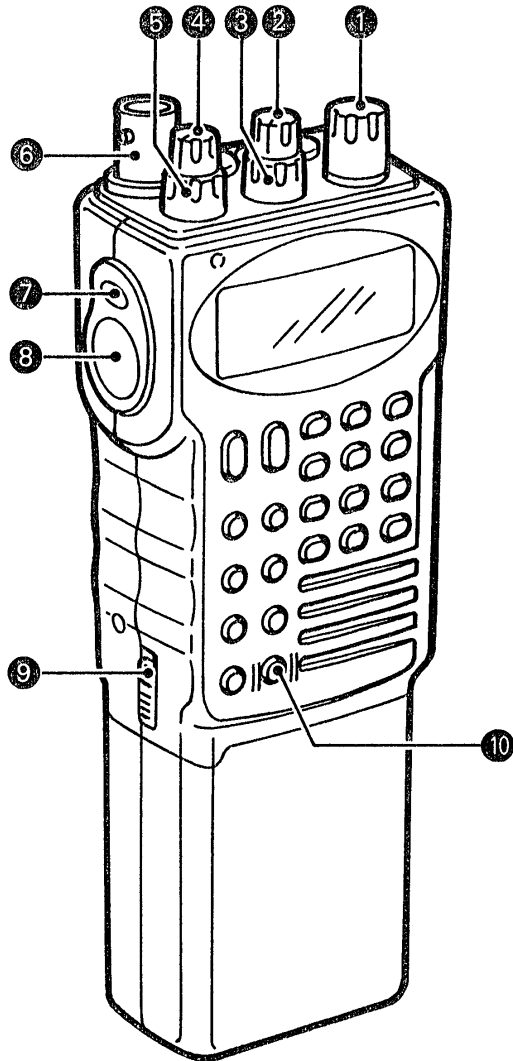

- ① **MAIN DIAL [DIAL]**
Sets an operating frequency, memory channel and SET mode contents.
- ② **RECEIVER VOLUME CONTROL [RX VOL] (p. 3)**
Adjusts the receiver band audio level.

- ③ **RECEIVER SQUELCH CONTROL [RX SQL]** (p. 3)
Varies the squelch threshold point for noise mute on the receiver band.
- ④ **HAM VOLUME CONTROL [HAM VOL]** (p. 3)
Adjusts the ham band audio level.
- ⑤ **HAM SQUELCH CONTROL [HAM SQL]** (p. 3)
Varies the squelch threshold point for noise mute on the ham band.
- ⑥ **ANTENNA CONNECTOR** (p. 2)
Connects the supplied ham antenna.
- ⑦ **FUNCTION SWITCH [F]**
While pushing [F], all switches are set for secondary function use. (Functions written in blue are secondary functions.)
 - In VFO mode, the dial select function is activated. The dial select function changes the memory channel or frequency in 100 kHz, 1 MHz or 10 MHz steps by rotating the main dial. (See p. 21 for details.)
- ⑧ **PTT SWITCH [PTT]** (pgs. 4, 22)
Push and hold to transmit on the ham band frequency; release to receive.

- ⑨ **BATTERY PACK RELEASE BUTTON** (p. 14)
Opens the latch for battery pack removal when pushed upwards. Slide the battery pack to the right for removal.
- ⑩ **POWER KEY [POWER]** (p. 3)
Turns power ON and OFF when pushed for 1 sec.
- ⑪ **EXTERNAL DC POWER JACK [DC12.5V]** (p. 11)
Connects the supplied wall charger for charging the battery pack.
 - Versions which have a battery case do not come with a wall charger.

Allows operation with a 12.5 V DC power source using the optional cables, CP-13 or OPC-288. (See separate "List of Options" for details.)
- ⑫ **EXTERNAL SPEAKER/MICROPHONE JACK [MIC/SP]**
Connects an optional speaker-microphone, if desired. (See separate "List of Options" for details.)
- ⑬ **RECEIVER ANTENNA JACK [RX ANT]** (p. 2)
Connects the supplied antenna for the receiver band when using the wideband receiver.

2 PANEL DESCRIPTION

■ Front panel

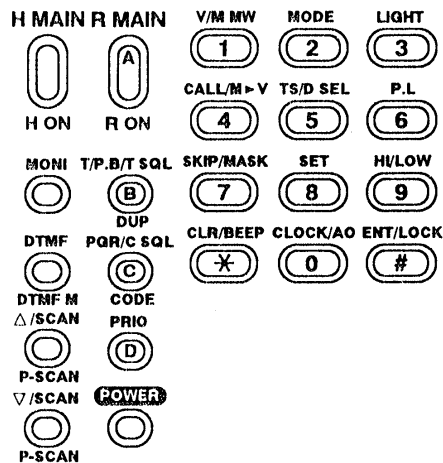

Primary function Secondary function

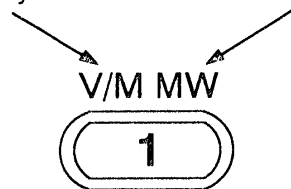

PRIMARY FUNCTION

(written in gray):

Activated by only pushing the key.

SECONDARY FUNCTION:

(written in blue)

Activated by pushing the key while holding the [F] switch on the side panel.

KEY	PRIMARY FUNCTION	SECONDARY FUNCTION
H MAIN 	Selects the ham band as the main band. (p. 3)	Activates the transceiver for the ham band only. (p. 48)
R MAIN 	Selects the receiver band as the main band. (p. 3)	Activates the transceiver for the receiver band only. (p. 48)
MONI 	Opens the squelch and the optional tone squelch* of the main band. (p. 31)	Opens the squelch and optional tone squelch* of the sub band. (p. 31)
T/P.B/T SQL 	Turns ON the following optional functions* in this sequence: subaudible tone encoder → pocket beep → tone squelch → non-tone operation. (p. 58)	Selects the duplex direction in this sequence: -duplex → +duplex → simplex. (p. 31)
DTMF 	Emits the programmed DTMF memory code. (p. 45)	Enters DTMF MEMORY mode to program the DTMF memory. (p. 46)
PGR/C SQL 	Turns ON the following optional functions in this sequence: Pager → code squelch → non-selective calling operation. (pgs. 53, 55)	Used for programming the code channel for the pager and code squelch. (p. 52)
	Changes the frequency. Starts the full scan or memory scan when pushed and held. (pgs. 18, 34)	Starts the programmed scan or memory skip scan. (p. 34)
PRIO 	Starts the priority watch. (p. 39)	No secondary function.
POWER 	Turns power ON and OFF when pushed for 1 sec. (p. 3)	The same function as at left.

*Built-in to the U.S.A. version

KEY	PRIMARY FUNCTION	SECONDARY FUNCTION	OTHER FUNCTION
V/M MW ①	Selects VFO or MEMORY mode. (pgs. 17, 25)	Writes the VFO contents into the memory channel or call channel when pushed and held. (pgs. 24, 26)	<p style="text-align: right;">ENT/LOCK #</p> <p>After pushing : Digit keys are activated for frequency input. (p. 19)</p> <p>While transmitting: Sends a DTMF digit. (p. 45)</p>
MODE ②	Selects receive mode on only the receiver band. (pgs. 4, 17)	No secondary function.	
LIGHT ③	Turns ON the display lighting for 5 sec. (p. 48)	Turns ON the display lighting continuously. (p. 48)	
CALL/M-V ④	Calls up the call channel. (p. 23)	Transfers the contents in the selected memory or call channel into the VFO. (pgs. 24, 27)	
TS/D SEL ⑤	Selects the tuning step. Use the switch together with the main dial. (p. 21)	Selects the dial select step from among 100 kHz, 1 MHz, 10 MHz or memory channel changing. (p. 21)	
P.L ⑥	No primary function.	Turns the PTT lock function ON and OFF. (p. 22)	
SKIP/MASK ⑦	Sets the selected memory channel as a skip memory channel. (p. 38)	Hides and displays the selected memory channel. Memory channel 1 cannot be hidden. (p. 28)	
SET ⑧	No primary function.	Selects SET mode. (p. 29)	
HI/LOW ⑨	Selects high or low output power. (p. 4)	Selects low output power in 3 levels. Use this function together with the main dial. (p. 22)	
CLR/BEEP ✱	Clears the entered digit before input. (p. 19) Exits the SET and CLOCK modes. (pgs. 29, 40)	Turns the beep function ON and OFF. (p. 48)	
CLOCK/AO 0	Enters the CLOCK mode. (p. 40)	Turns the auto power-off function ON and OFF. Use this function together with the main dial. (p. 47)	
ENT/LOCK #	Sets the keyboard for numeral use. (p. 19)	Turns the lock function ON and OFF. (p. 17)	

2 PANEL DESCRIPTION

■ Function display

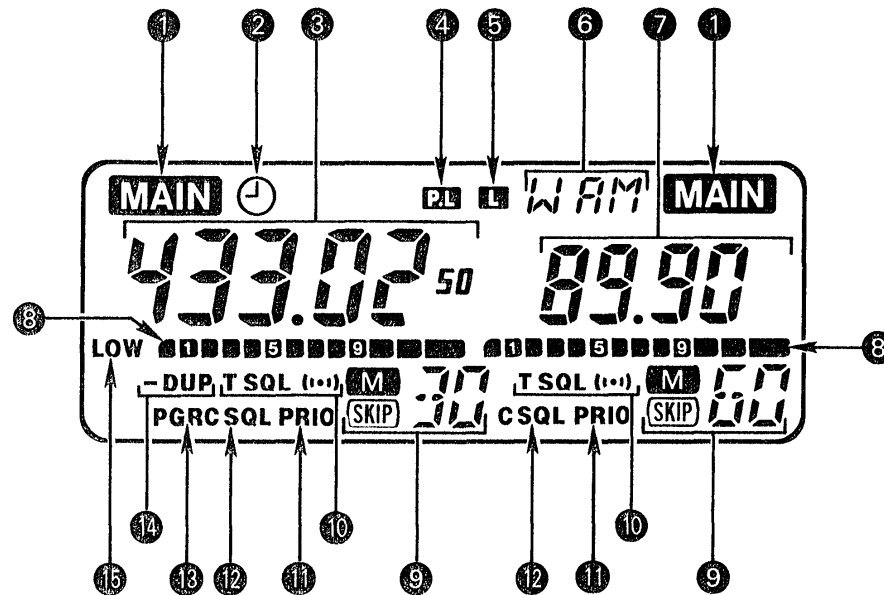

- 1 MAIN BAND INDICATORS** (p. 3)
“ MAIN ” appears above the band, either ham or receiver, selected as the main band to be controlled.
- 2 TIMER INDICATOR** (p. 43)
Appears when the power-off timer is in use.
- 3 HAM BAND FREQUENCY READOUT**
Shows the ham band frequency, SET mode contents or time.
 - The decimal point of the frequency flashes while scanning.
- 4 PTT LOCK INDICATOR** (p. 22)
Appears when the PTT lock function is in use.
- 5 LOCK INDICATOR** (p. 17)
Appears when the lock function is in use.
- 6 RECEIVE MODE INDICATOR** (pgs. 4, 17)
Shows the selected receive mode for the receiver band.
- 7 RECEIVER BAND FREQUENCY READOUT**
Shows the receiver band frequency, SET mode contents or time.
 - The decimal point of the frequency flashes while scanning.

8 S/RF INDICATORS (p. 22)

Show the relative signal strength in receiving; show the output power selection* in transmitting.

*Only for the ham band's indicator.

9 MEMORY CHANNEL INDICATORS (p. 25)

Show the selected memory channel number.

- “**M**” appears when MEMORY mode is selected.
- “**SKIP**” appears when the selected memory channel is set as a skip channel.
- “**[]**” appears when a call channel is selected.

10 TONE SQUELCH INDICATORS (pgs. 31, 58)

These indicators appear when an optional* UT-63 TONE SQUELCH UNIT is in use.

- “**T**” appears when the subaudible tone encoder is used.
- “**T SQL**” appears when the tone squelch is used.
- “**T SQL (••)**” appears when the pocket beep function is in use.
- “**(••)**” flashes when the pocket beep function is in use and receiving a call.

*Built-in to the U.S.A. version.

11 PRIORITY INDICATORS (p. 39)

Appear when the priority watch is activated; flashes when the watch is paused.

12 CODE SQUELCH INDICATORS (p. 55)

Appear when the code squelch is in use.

13 PAGER INDICATOR (p. 53)

Appears when the pager function is turned ON; flashes when a call is received.

14 DUPLEX INDICATOR (p. 31)

Appears when duplex is used for repeater operation.

- “**DUP**” appears when +duplex is selected. (Use +duplex when the repeater input frequency is higher than the repeater output frequency.)
- “**-DUP**” appears when -duplex is selected. (Use -duplex when the repeater input frequency is lower than the repeater output frequency.)

15 LOW POWER INDICATOR (pgs. 4, 22)

Appears when low output power is selected.

3

BATTERY PACK CHARGING

• Regular charging

Connect the supplied wall charger to the [DC12.5V] jack.

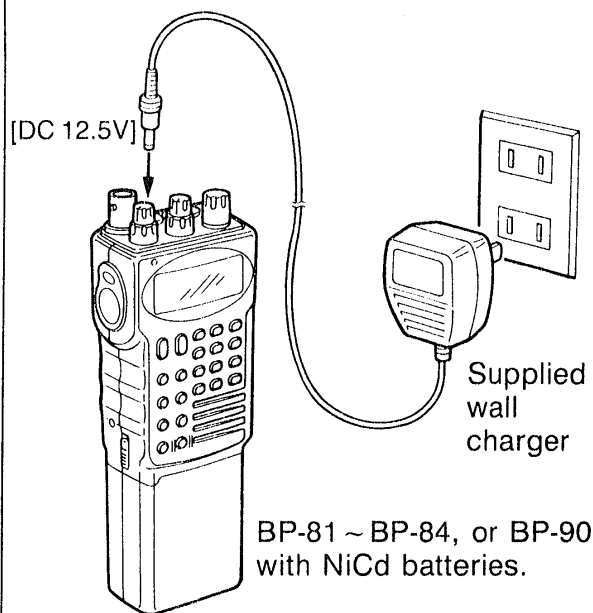

Charging period: 15 hrs. (approx.)

• Rapid charging with optional BC-72

Insert the battery pack into the charging slot of the BC-72.

BP-90 BATTERY CASE cannot be charged using the BC-72 even when NiCd batteries are installed.

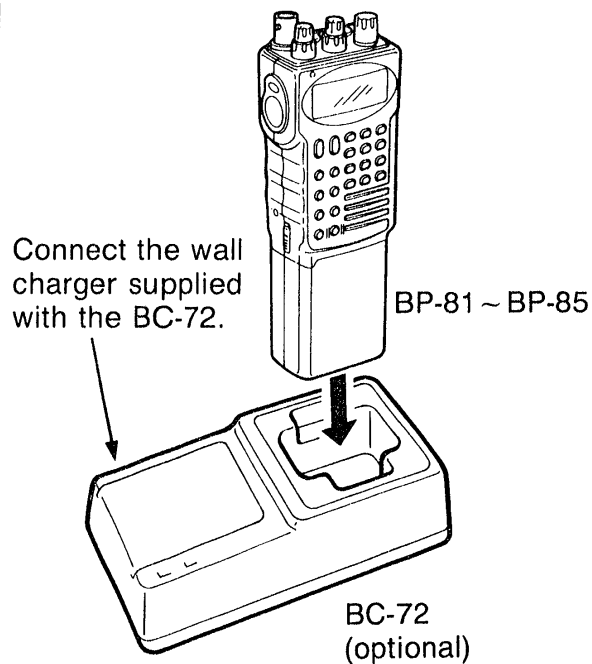

Charging period: 1 ~ 3 hrs. (approx.)

• Charging with optional charger or cable

CP-13 (optional)

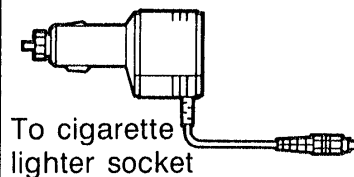

OPC-288 (optional)
white ⊕

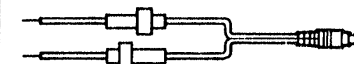

black ⊖

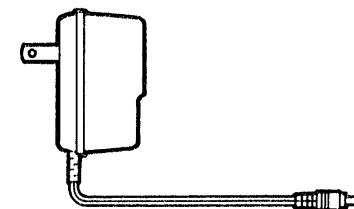

BC-77A/E/D/V
For BP-81 ~ BP-84 and BP-90.

BC-78E/D
For BP-81 and BP-82.

To charge BP-85, use BC-74A/E/D/V, CP-12 or OPC-254.

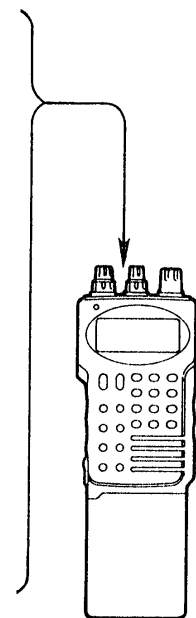

BP-81 ~ 84
or BP-90

Charging period: 15 hrs. (approx.)

• **Charging without the transceiver**

To charge the battery pack separately from the transceiver, the AD-20 is available from Icom.

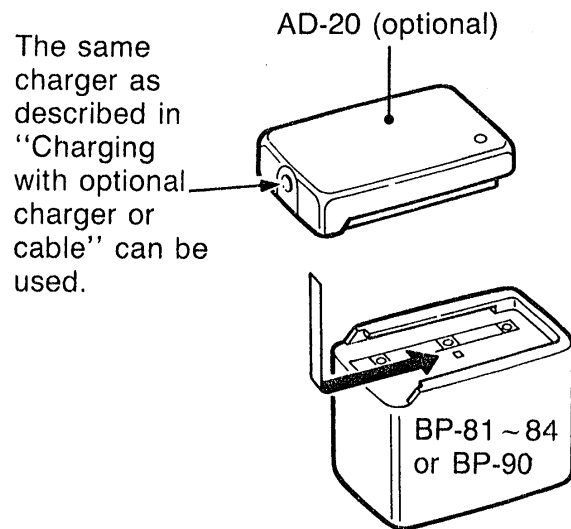

Optional BC-74A/E/D/V, CP-12 or OPC-254 must be connected to charge a BP-85.

Charging period: 15 hrs. (approx.)

• **Charging notes**

NEVER attempt to charge dry cell batteries.

Connect one charger. **NEVER** connect two or more chargers at the same time.

When transceiver power is ON during charging, the charging period is longer than the described time.

Charging may not be performed in extreme cold (under 0°C; +32°F) or extreme heat (over +40°C; +104°F).

• **Using your battery wisely**

Although battery packs may not be affected by charging periods of one week or more, overcharging and complete discharging shorten the life of a battery.

Recharging can usually be performed 300 times, but battery life can be lengthened to about 500 recharges as follows:

1. Avoid overcharging. Charging period should be less than 48 hours.
2. Use the battery until it is almost completely discharged under normal conditions. We recommend battery charging as soon as transmitting becomes impossible.

• **Battery life**

Depending on the battery packs, the operating period changes.

- **Condition 1:** Transmitting at high power for 1 min., receiving for 1 min. and standby for 8 min.
- **Condition 2:** Continuous receiving.

BATTERY	OUTPUT VOLTAGE	APPROX. OPERATING PERIOD*	
		Condition 1	Condition 2
BP-81	7.2 V	1 h	1 h
BP-82	7.2 V	2 h. 30 m.	3 h. 40 m.
BP-83	7.2 V	5 h. 20 m.	5 h. 30 m.
BP-84	7.2 V	9 h. 10 m.	9 h. 10 m.
BP-85	12.0 V	1 h. 30 m.	3 h. 40 m.

*Operating period varies depending on operating conditions such as output power, temperature, etc.

4

ACCESSORY ATTACHMENT

• Handstrap

The handstrap allows you to carry the transceiver easily. Attach the handstrap as shown in the diagram below.

1. Insert the handstrap using a pointed tool such as a sharp pencil.

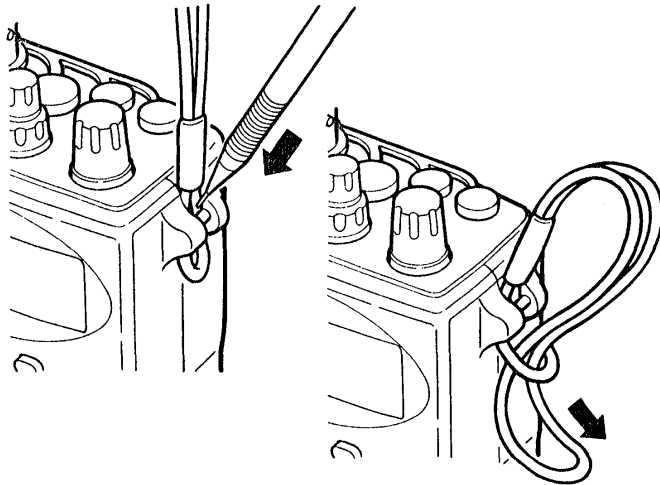

2. Put one end of handstrap through the other end's loop.

3. Pull the handstrap to tighten the knot.

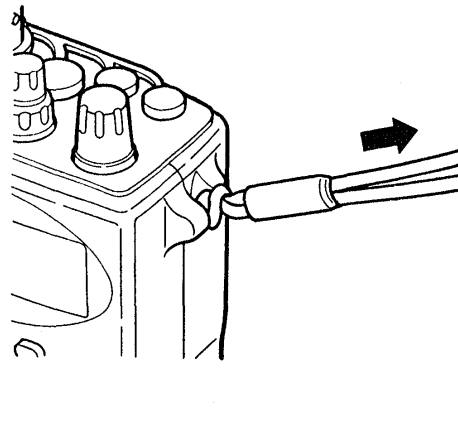

• Belt clip

The belt clip allows you to attach the transceiver to your belt.

Remove the plastic screws to attach the belt clip.

To use an optional MB-20 ALLIGATOR CLIP with the IC-4SRA/E, use the supplied screws with the transceiver. NEVER use the screws supplied with the alligator clip.

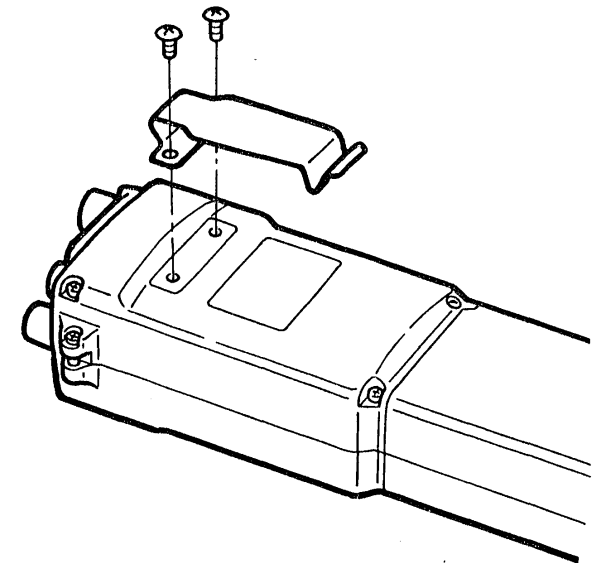

• Battery pack removal

Push the battery pack release button upwards, then slide the battery pack to the right with the transceiver facing you.

To attach the battery pack, slide it until hearing a click sound.

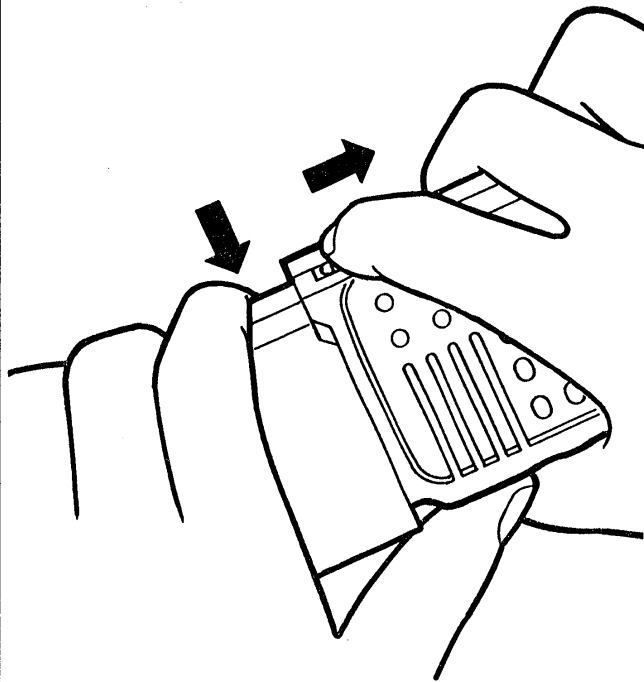
**• Battery case**

Some versions include the BP-90 BATTERY CASE instead of the battery pack.

To install dry cell batteries, open the battery case as shown in the diagram below.

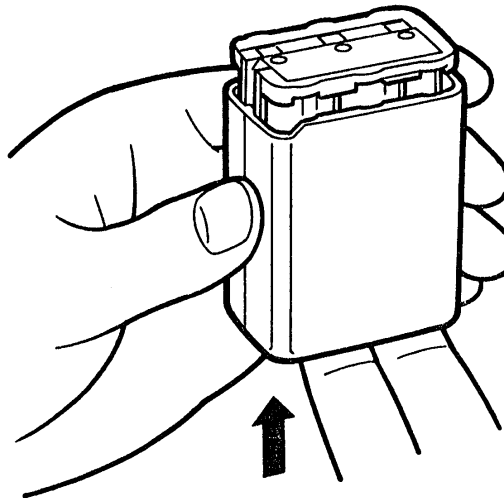

1. Push the bottom part of the battery case to open it.

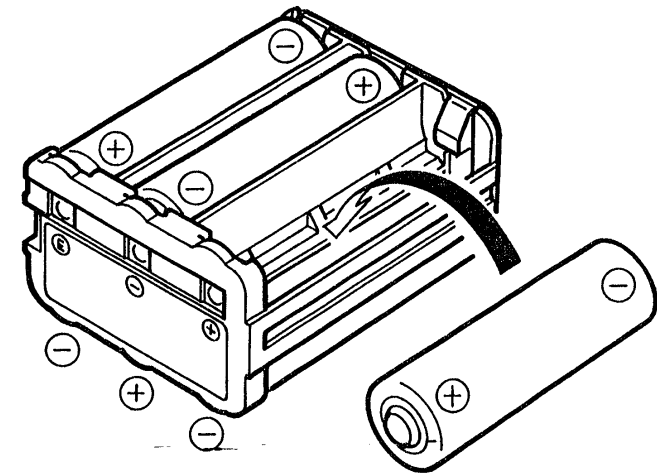

2. Install six AA (R6) type batteries. Be careful of the polarity of the batteries.

5

MODE CONSTRUCTION

Mode types

VFO MODE
(frequency setting) (p. 17)

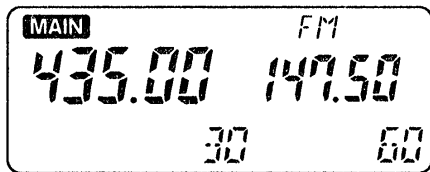

Used for frequency setting and normal operations over the entire ham and receiver band.

SET MODE (p. 29)

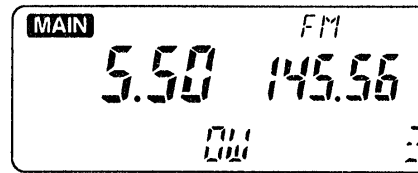

Used for programming infrequently used settings. The ham and receiver bands have separate SET modes.

MEMORY MODE (p. 25)

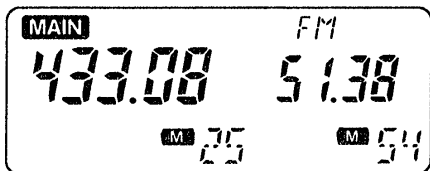

Used for operating the transceiver using memory channel contents. The ham band has 30 and the receiver band has 60 memory channels.

DTMF MEMORY MODE (p. 45)

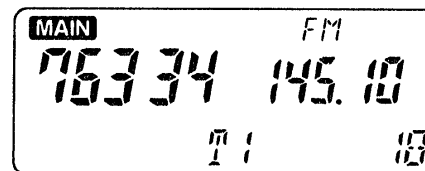

Used for programming DTMF codes. 4 DTMF memory channels are available and each memory channel has up to 15 digits of programming capability.

CALL CHANNEL (p. 23)

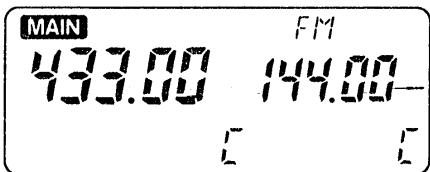

Used for operating the transceiver on a programmed call channel. The ham and receiver bands have their own separate call channel.

CLOCK MODE (p. 40)

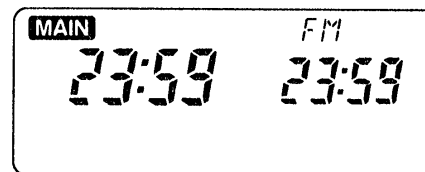

Used for indicating or setting the clock time, power-on timer and power-off timer.

Changing modes

Although the following chart refers only to the ham band, the transceiver has the same modes in the receiver band.

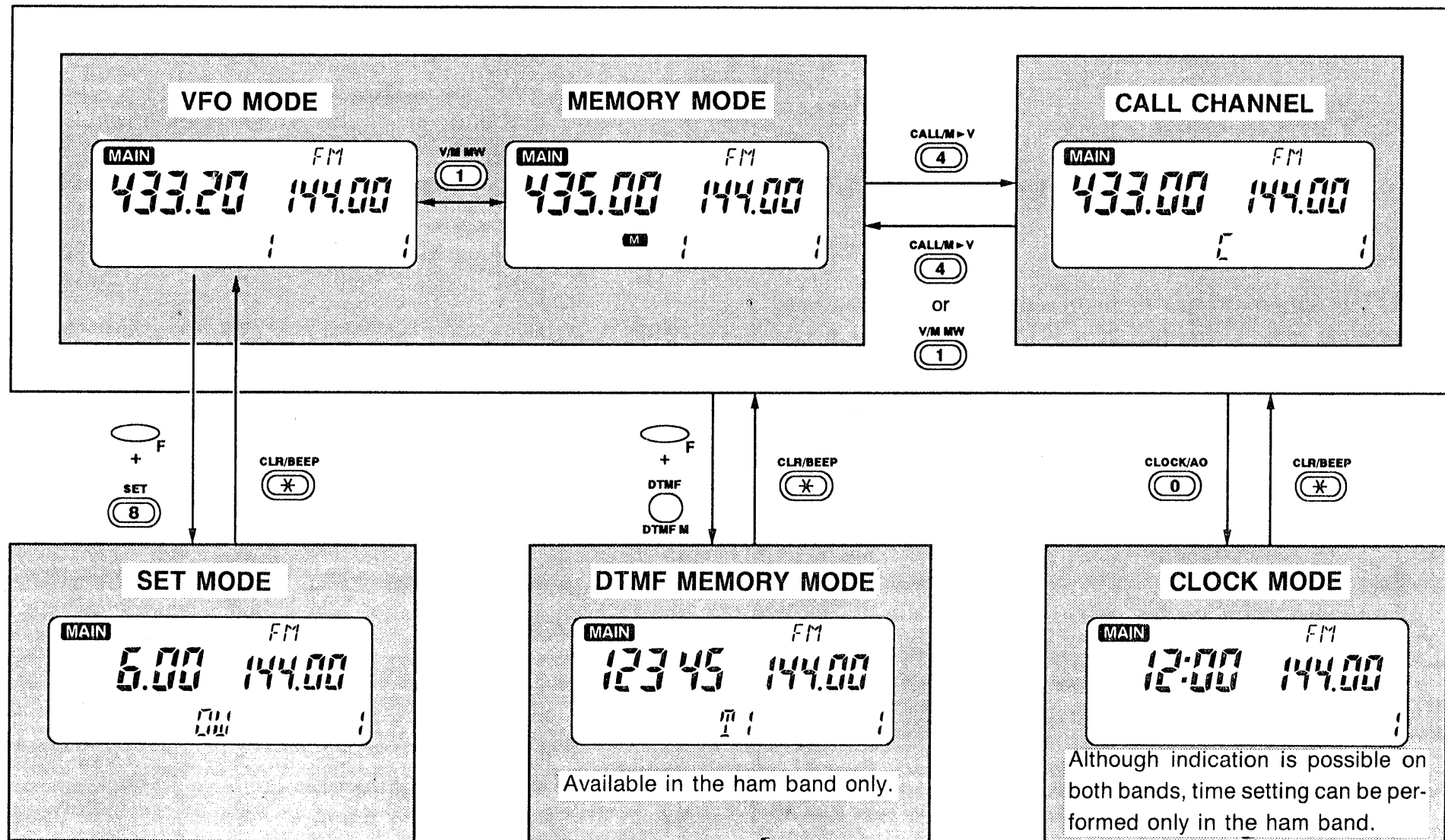

6

FREQUENCY SETTING

■ Selecting VFO mode

When the transceiver is not in VFO mode, push [① V/M] once or twice to select VFO mode.

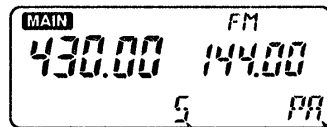

VFO mode

Only channel numbers or "PA" or "PB" are indicated. If "M" or "L" is indicated here, VFO mode is not selected.

NOTE: When the lock function is activated, the keyboard and main dial cannot be used, and the mode cannot be changed.

• Lock function

To prevent accidental frequency changes and unnecessary function access, the lock function is available.

While pushing [F] on the side panel, push [Ⓢ LOCK] to activate the function.

To deactivate the function, while pushing [F], push [Ⓢ LOCK] again.

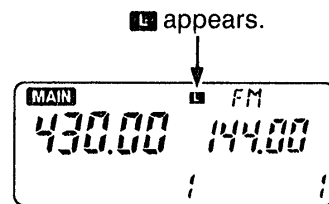

■ Selecting receive mode

For the receive band, the receive mode must be selected properly.

- 1) Push [R MAIN] to select the receiver band.
- 2) Push [② MODE] to select the desired receive mode.
 - AM, FM and WFM are available.
 - The receive mode of the ham band is always FM regardless of the receiver band's mode.

• Receive mode information

RECEIVE MODE	COMMUNICATION EXAMPLE
FM	Amateur bands Citizen bands Utility communication Marine bands
WFM (Wide FM)	TV broadcasting FM broadcasting
AM	AM broadcasting TV broadcasting Amateur bands Citizen bands Air bands

■ Setting a frequency

• Using the main dial

- 1) Push [H MAIN] or [R MAIN] to select the desired band.
 - Select VFO mode if another mode has been selected.
- 2) Rotate the main dial to set the frequency.
 - The frequency changes according to the tuning step.
 - See p. 21 for changing the tuning step.
- 3) To change the frequency quickly, rotate the main dial while pushing [F].
 - See p. 21 "Dial select step" for details.

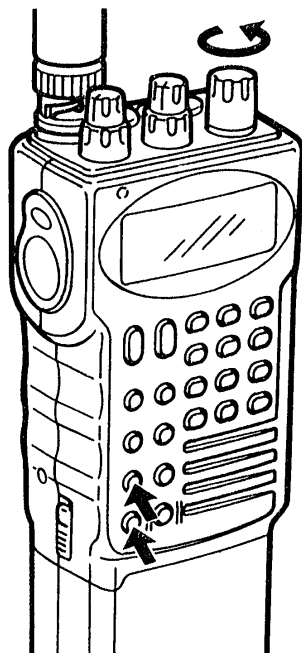

Main dial

Δ/▽ keys

• Using the Δ/▽ keys

- 1) Push [H MAIN] or [R MAIN] to select the desired band.
 - Select VFO mode if another mode has been selected.
- 2) Push [Δ/SCAN] or [▽/SCAN] to change the frequency.
 - The frequency changes according to the tuning step.
 - See p. 21 for changing the tuning step.
 - Holding the key for more than 0.5 sec. will activate full scan.
 - If the scan is started, push [Δ/SCAN] or [▽/SCAN] again to stop the scan.

NOTE: When the pager or code squelch function is activated, frequency setting by the Δ/▽ keys is impossible. Push [PGR/C SQL] several times until "PGR" or "C SQL" disappears to cancel the function.

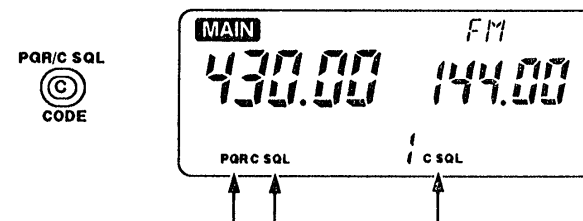

See pgs. 53 and 55 for details.

6 FREQUENCY SETTING

• Using the numeral keys

- 1) Push [H MAIN] or [R MAIN] to select the desired band.
 - Select VFO mode if another mode has been selected.
- 2) Push [# ENT] to activate the keyboard for numeral input.
- 3) Push appropriate keys to input a frequency.
 - The first digit for frequency input can be shifted in SET mode for the receiver band. See the box at right for details.
 - When the “hundreds” MHz place is selected as the first digit for frequency input, frequencies lower than 100 MHz are input by entering “0” before entering the first digit.
 - “0” is acceptable for the 1 kHz digit (last digit); “2,” “5” or “7” are also acceptable depending on the 10 kHz digit.
- 4) When a wrong digit is entered, push [* CLR] to clear the entered digits and start again from step 2.

USING SET MODE

CHANGING THE FIRST DIGIT FOR FREQUENCY INPUT

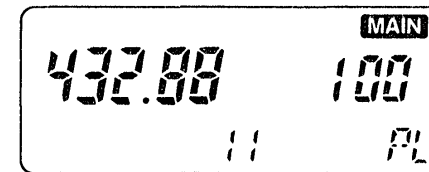

The display shows the “hundreds” MHz place as the first digit for frequency input.

- 1) Push [R MAIN] to select the receiver band.
 - The ham band has this SET mode item depending on the version.
- 2) Push [① V/M] to select VFO mode if another mode has been selected.
- 3) While pushing [F], push [⑧ SET] to enter SET mode.
 - Refer to p. 29 for SET mode details.
- 4) Push [Δ/SCAN] or [▽/SCAN] until “PL” appears as shown above.
- 5) Rotate the main dial to select the desired MHz place as the first digit for frequency input.
- 6) Push [* CLR] to exit SET mode.

[EXAMPLE]: Setting the frequency to 435.240 MHz on the ham band.

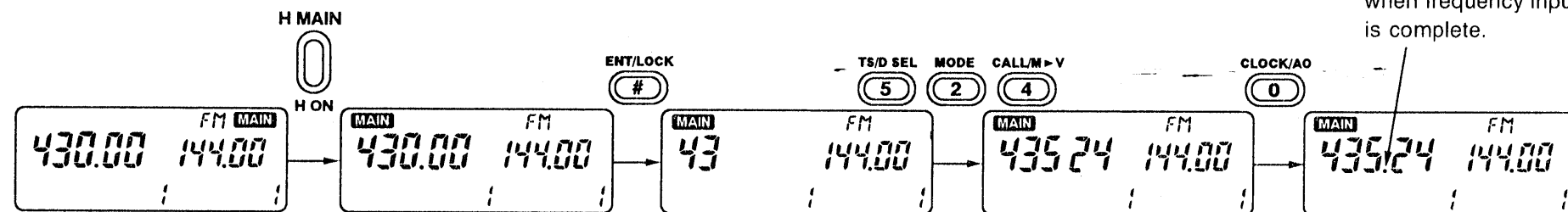

[EXAMPLE]: Setting the frequency to 52.180 MHz on the receiver band.
(When 100 MHz is selected as the first digit for frequency input.)

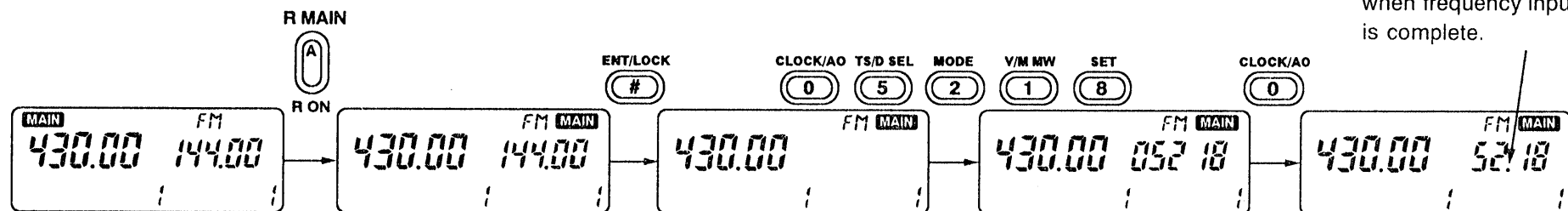

[EXAMPLE]: Setting the frequency to 145.365 MHz on the receiver band.
(When 10 MHz is selected as the first digit for frequency input.)

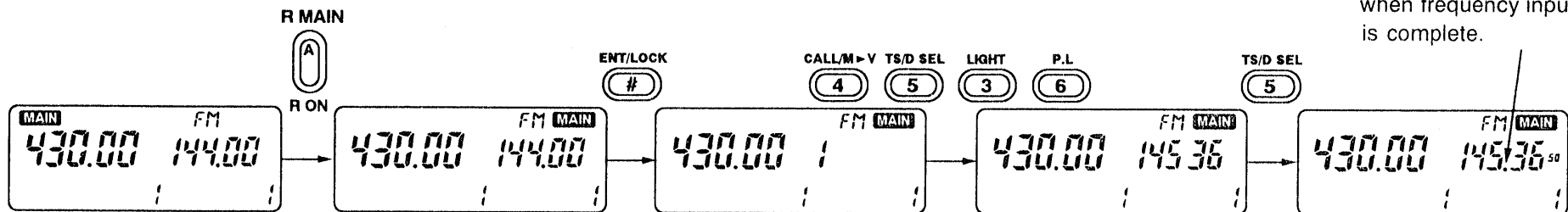

6 FREQUENCY SETTING

■ Tuning step

The main dial or the Δ/∇ keys change the frequency in step increments. Different tuning steps can be specified for the ham, high-frequency and low-frequency receiver bands.

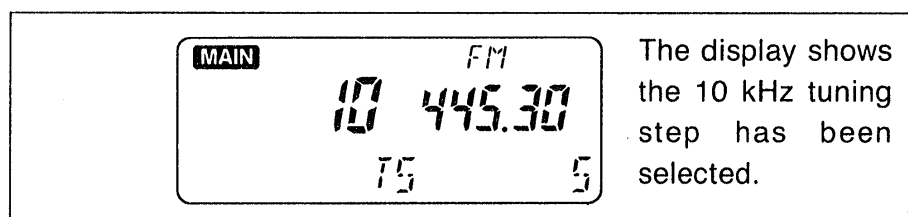

- 1) Push [H MAIN] or [R MAIN] to select the desired band.
- 2) Push [① V/M] to select VFO mode if another mode has been selected.
- 3) Push [⑤ TS] to display the previously selected tuning step.
- 4) Rotate the main dial to select the desired tuning step.

BAND	RANGE	AVAILABLE TUNING STEPS
Ham	430 ~ 440 or 440 ~ 450 MHz	5, 10, 12.5, 15, 20, 25, 30, 50 kHz
Receiver	25 ~ 267.8 MHz	5, 10, 12.5, 15, 20, 25, 30, 50 kHz
	267.8 ~ 950 MHz	10, 12.5, 20, 25, 30, 50 kHz

- 5) Push [⊛ CLR] to return to frequency indication.

■ Dial select step

In VFO mode, while pushing the [F] key, the main dial changes the frequency or memory channel number in the following increments. This function is useful for quick frequency selection or memory channel selection in VFO mode.

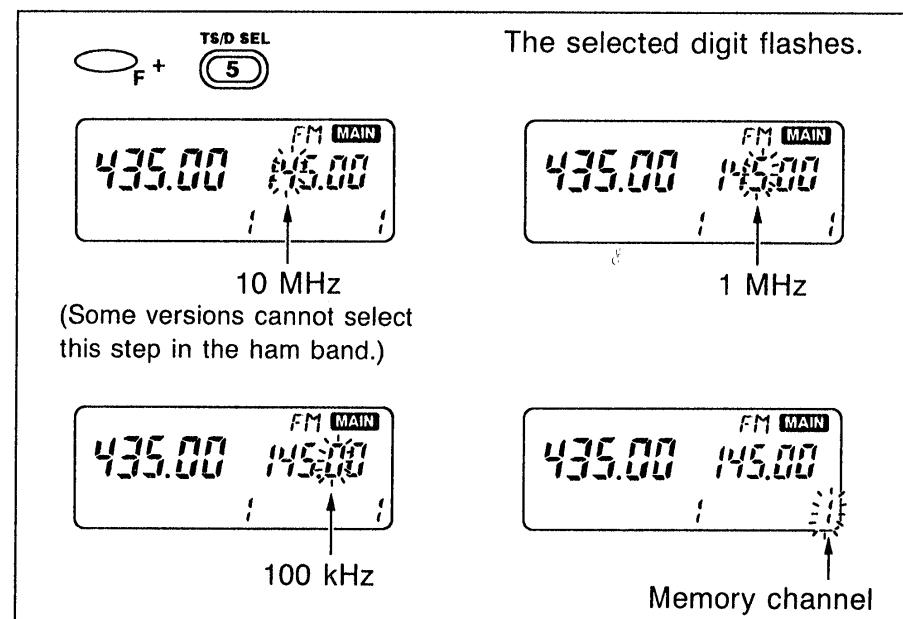

- 1) Push [H MAIN] or [R MAIN] to select the desired band.
 - Each band has a separate dial select step.
- 2) While pushing [F], push [⑤ D SEL] several times to change the dial select step.
 - The selected digit flashes while pushing [F].



□ Transmitting

The transceiver transmits only on the ham band; it cannot transmit on the receiver band.

Be sure the ham antenna is connected to the ham antenna connector. Transmitting without the ham antenna damages the transceiver.

- 1) Push [H MAIN] to select the ham band.
- 2) Set the frequency.
 - To select a call or memory channel, see p. 23 or p. 25.
- 3) Push [⑨ HI/LOW] to select high or low output power.
 - “LOW” appears when low power is selected.
- 4) Push and hold [PTT] to transmit.
 - The LED indicator on the front panel lights up in red while transmitting.
 - “o.FF” appears on the receiver band frequency readout and the circuit is deactivated while transmitting.
- 5) Speak into the microphone.
 - DO NOT hold the transceiver too closely to your mouth or speak too loudly. This may distort the signal.
- 6) Release [PTT] to receive.

□ Low output power level

Low output power can be selected in 3 levels to suit operating requirements.

- 1) Push [H MAIN] to select the ham band.
- 2) While pushing [F], push [HI/LOW]; then, while continuing to hold [F], rotate the main dial to set the desired level.
 - S/RF indicator shows the selected level below.

Power selection	S/RF indicator	Output power	
		with 12.5 V	with 7.2 V
High		5.0 W	1.5 W
Low 3	LOW	3.5 W	1.5 W
Low 2	LOW	1.5 W	1.5 W
Low 1	LOW	0.5 W	0.5 W

□ PTT lock

The PTT lock function electronically locks the PTT switch to prevent accidental transmission.

Appears when the PTT is locked.

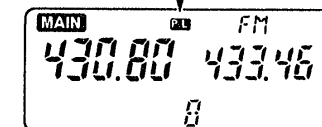

While pushing [F], push [⑥ P.L.] to turn the PTT lock function ON and OFF.

8

CALL CHANNEL

■ General description

A one-touch access call channel is provided on each band. These call channels are separate from the memory channels. Use the call channel for your most-often-used frequency. You can program the following data into a call channel.

THE CALL CHANNEL ON THE HAM BAND

- Operating frequency
- Duplex information (DUP or –DUP)
- Offset frequency
- Subaudible tone frequency*
- Tone encoder ON/OFF*
- Tone squelch ON/OFF*

THE CALL CHANNEL ON THE RECEIVER BAND

- Operating frequency
- Receive mode
- Subaudible tone frequency*
- Tone squelch ON/OFF*

*An optional UT-63 TONE SQUELCH UNIT is necessary except for the U.S.A. version.

■ Calling up a call channel

- 1) Push [H MAIN] or [R MAIN] to select the desired band.
 - 2) Push [④ CALL] to display the call channel.
 - “C” appears.
 - 3) Push [④ CALL] again to return to the previous mode.

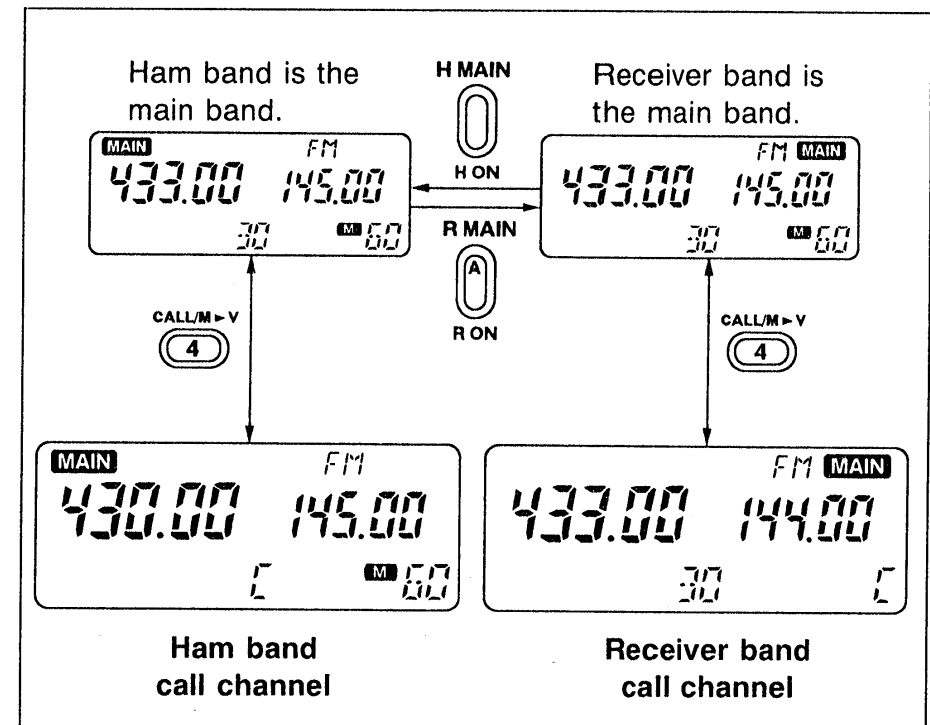

■ Programming

- 1) Push [H MAIN] or [R MAIN] to select the desired band.
- 2) Push [① V/M] to select VFO mode.
- 3) Set the desired frequency to be programmed into the call channel.
 - Set the other data that can be programmed in the call channel if required.
- 4) Push [④ CALL] to call up the call channel.
- 5) While pushing [F], push and hold [① MW] until the transceiver emits 3 beeps.

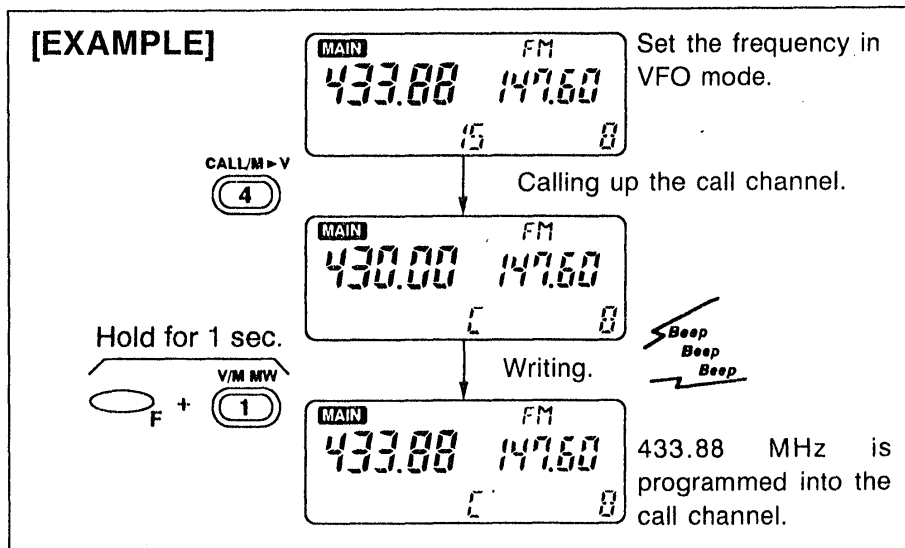

■ Transferring contents to VFO

This function transfers the call channel contents into the VFO. This is useful for searching for signals around the call channel frequency and for recalling the offset frequency, subaudible tone frequency, etc. which are programmed in the call channel.

- 1) Push [H MAIN] or [R MAIN] to select the desired band.
- 2) Push [④ CALL] to call up the call channel.
- 3) While pushing [F], push and hold [④ M▶V] until the transceiver emits 3 beeps.
 - VFO mode is automatically selected.

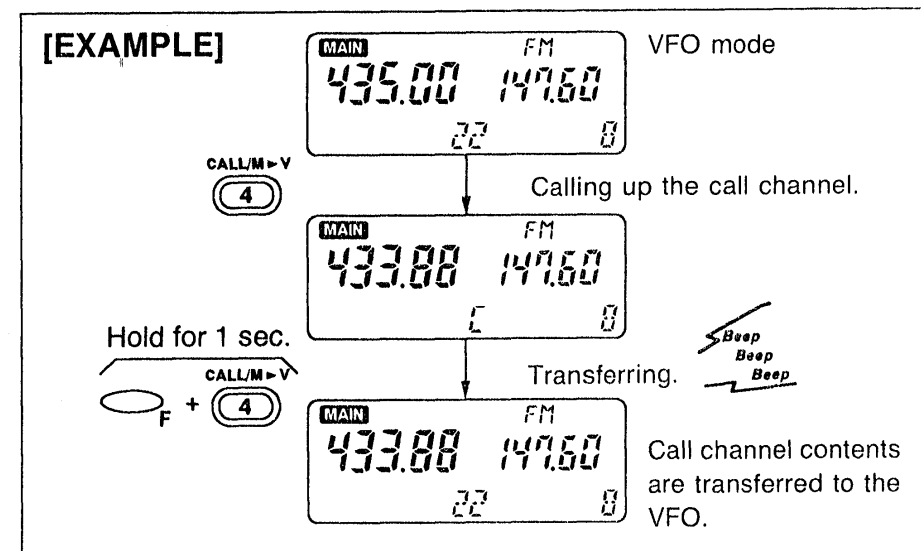

9

MEMORY MODE

■ General description

The transceiver has 30 memory channels for the ham band and 60 memory channels for the receiver band. Use memory channels for your often-used frequencies. You can program the following data into a memory channel.

THE MEMORY CONTENTS ON THE HAM BAND

- Operating frequency
- Duplex direction (DUP or –DUP)
- Offset frequency
- Subaudible tone frequency*
- Tone encoder ON/OFF*
- Tone squelch ON/OFF*

THE MEMORY CONTENTS ON THE RECEIVER BAND

- Operating frequency
- Receive mode
- Subaudible tone frequency*
- Tone squelch ON/OFF*

*An optional UT-63 TONE SQUELCH UNIT is necessary except for the U.S.A. version.

When first applying power or after resetting, ham memory channels 11 ~ 30 and receiver memory channels 11 ~ 60 are masked.

■ Selecting a memory channel

- 1) Push [H MAIN] or [R MAIN] to select the desired band.
- 2) Push [① V/M] to select MEMORY mode.
 - “M” appears.
- 3) Rotate the main dial to select the desired memory channel.
 - Only the memory channels which have been programmed with contents and have not been masked will appear.
 - While pushing [F], rotate the main dial to select memory channels which are masked or not programmed.
 - Pushing [Δ/SCAN] or [▽/SCAN] also selects memory channels.
 - Holding the [Δ/SCAN] or [▽/SCAN] for more than 0.5 sec. will activate memory scan. If the scan is started, push [Δ/SCAN] or [▽/SCAN] again to stop the scan.
- 4) To return to VFO mode, push [① V/M].

[EXAMPLE]: Selecting memory channel 25.

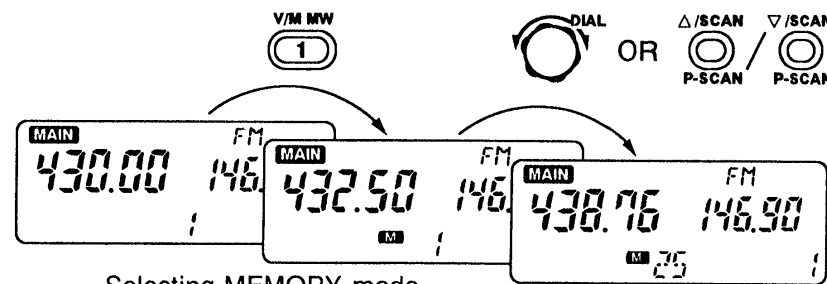

Selecting MEMORY mode.

Selecting a memory channel.

■ Programming

- 1) Push [H MAIN] or [R MAIN] to select the desired band.
- 2) Select the memory channel to be programmed:
 - Push [① V/M] to select MEMORY mode. ("M" appears.)
 - Rotate the main dial to select the desired memory channel.
 - To select blank or masked memory channels, rotate the main dial while pushing [F].
- 3) Set the desired frequency in VFO mode:
 - Push [① V/M] to select VFO mode.
 - Set the desired frequency to be programmed into the memory channel.
 - Set the other data (e.g. duplex information), if required.
- 4) While pushing [F], push and hold [① MW] until the transceiver emits 3 beeps.

[EXAMPLE]: Programming 433.260 MHz into ham memory channel 25.

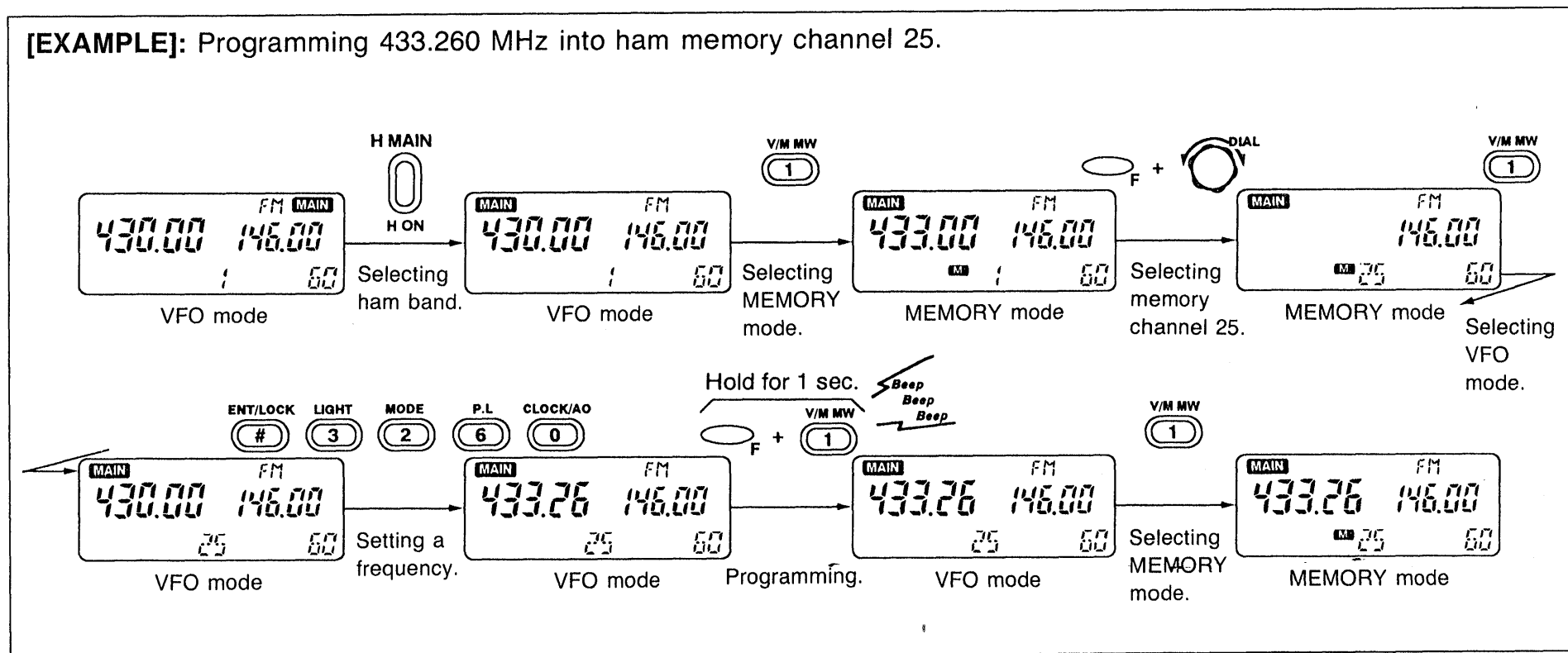

9 MEMORY MODE

■ Transferring contents to VFO

This function transfers the memory channel contents into the VFO. This is useful for searching for signals around the displayed memory channel frequency and for recalling the offset frequency, subaudible tone frequency, etc. which are programmed in the memory channel.

- 1) Push [H MAIN] or [R MAIN] to select the desired band.
- 2) Select the memory channel to be transferred:
 - Push [① V/M] to select MEMORY mode.
 - Rotate the main dial to select the desired memory channel.
- 3) While pushing [F], push and hold [④ M▶V] until the transceiver emits 3 beeps.
 - “M” disappears as VFO mode is automatically selected.

[EXAMPLE]: Transferring the contents of memory channel 25 into the VFO.

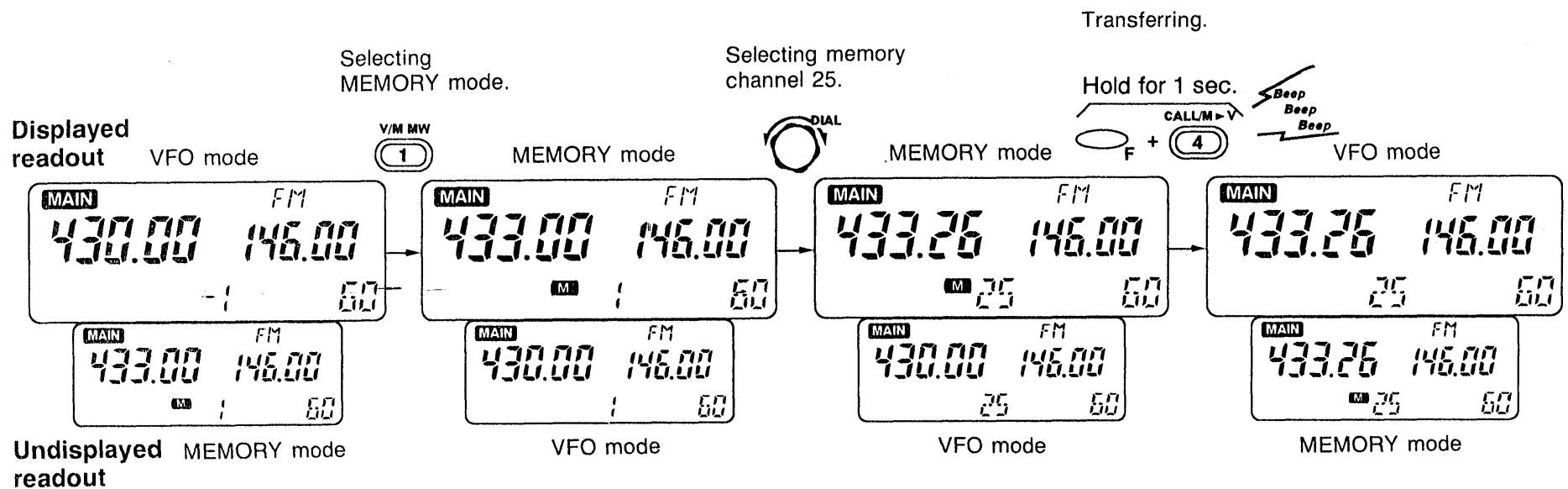

■ Masking a memory channel

Unwanted memory channels can be masked (hidden). A masked memory channel cannot be selected for normal use. The contents in the masked memory channel, however, can be recalled.

- 1) Push [H MAIN] or [R MAIN] to select the desired band.
- 2) Select the memory channel to be masked:
 - Push [① V/M] to select VFO mode.
 - Rotate the main dial to select the desired memory channel.

- 3) While pushing [F], push and hold [⑦ MASK].
 - Frequency, etc. disappear.
- 4) To recall the masked contents, repeat step 3.
 - To select masked memory channels, rotate the main dial while pushing [F].

NOTE: Only memory channel 1 cannot be masked.

[EXAMPLE]: Masking memory channel 25.

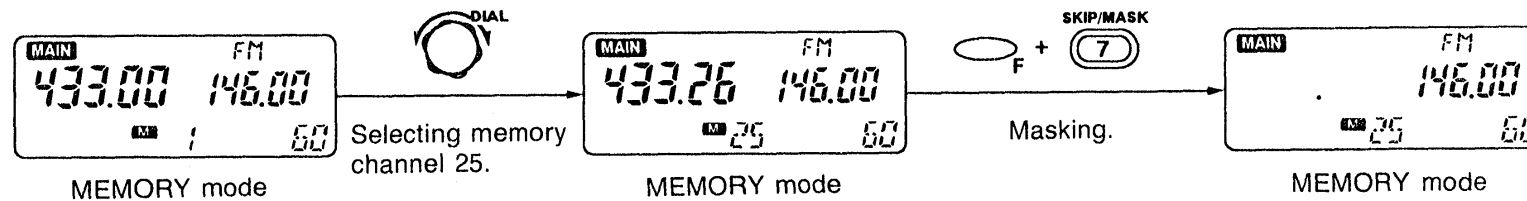

[EXAMPLE]: Recalling the masked contents in memory channel 25.

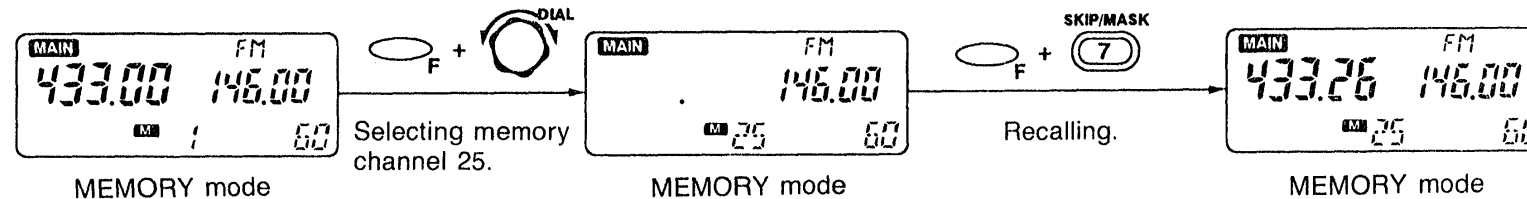

10 SET MODE

OFFSET FREQUENCY

(p. 32)

The offset frequency is used for duplex operation such as operation with a repeater.

- This item is equipped on only the ham band.

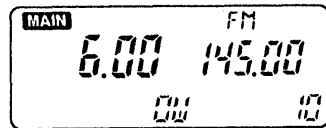

SCAN RESUME CONDITION

(p. 35)

Timer scan or pause scan can be selected as the scan resume condition.

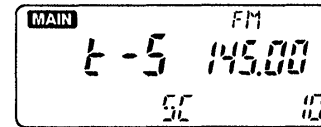

SUBAUDIBLE TONE FREQUENCY

(p. 32)

Some repeaters require a subaudible tone, and the tone is also used for pocket beep and tone squelch functions.

- To use the tone, an optional UT-63 is necessary for all versions except U.S.A.

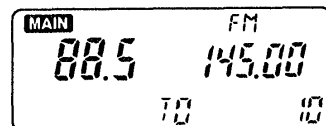

SCAN SKIP FUNCTION

(p. 38)

The scan skip function for full and programmed scan can be turned ON and OFF.

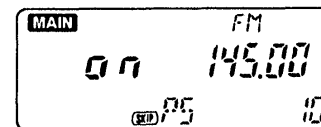

THE FIRST DIGIT FOR FREQUENCY INPUT

(p. 19)

The first digit for frequency input with the numeral keys can be selected from 100 MHz, 10 MHz and 1 MHz places.

- This item is equipped only on the receiver band with some versions.

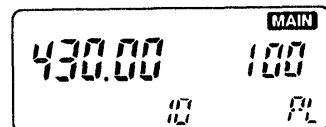

DUTY RATE FOR THE POWER SAVER FUNCTION

(p. 47)

This is the rate of the standby condition and circuit off condition for the power saver.

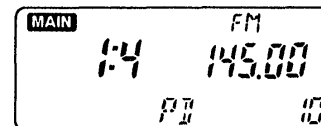

This mode is used for rarely changed functions and settings as follows. Each band has a SET mode.

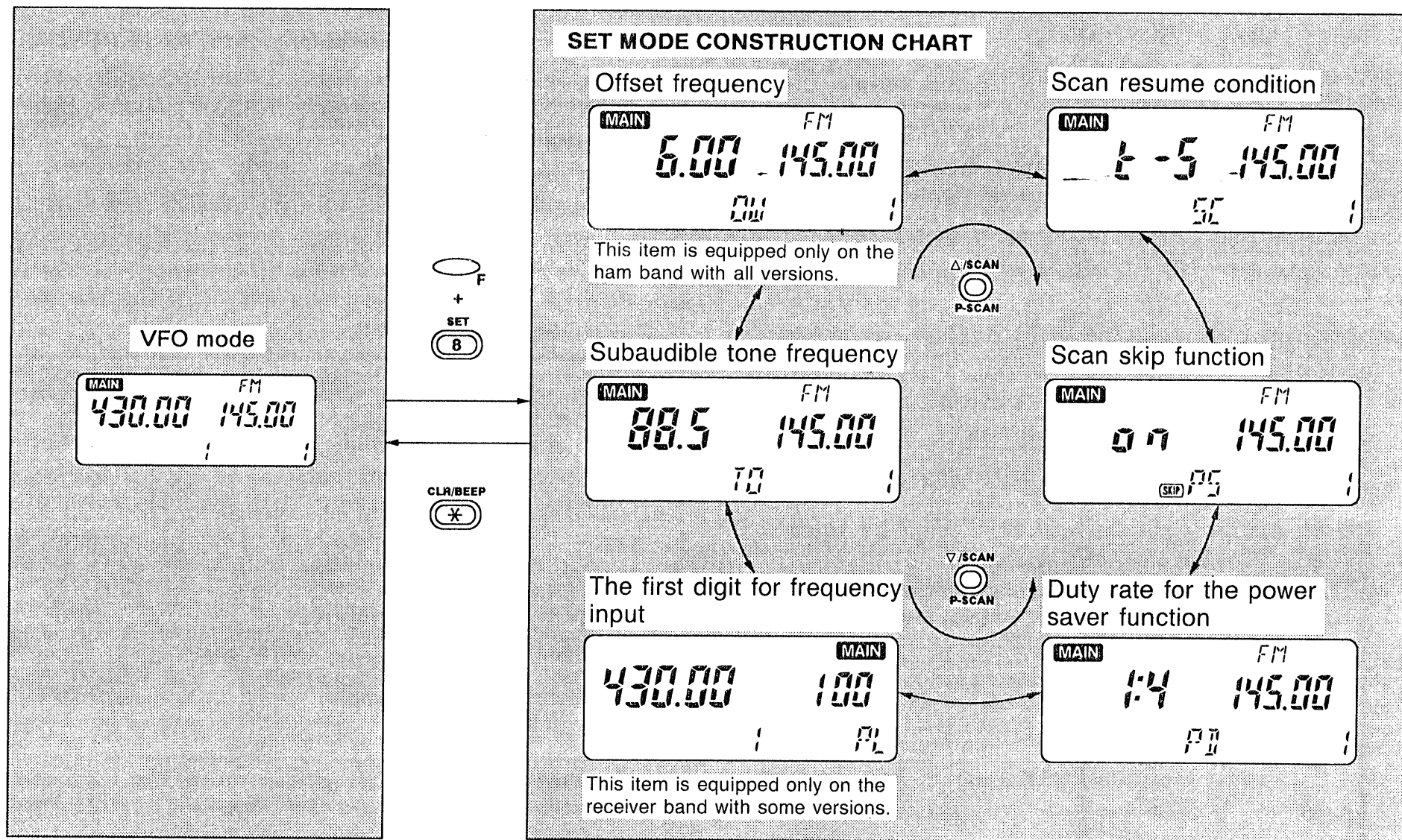

11 REPEATER OPERATION

Operation

A repeater amplifies a received signal and transmits it with a different frequency. When using a repeater, the transmit frequency is, therefore, shifted from the receive frequency by the offset frequency.

- 1) Push [H MAIN] to select the ham band.
- 2) Set the receive frequency (repeater output frequency) using the main dial or the keyboard.
- 3) While pushing [F], push [Ⓟ DUP] to select – duplex and push it again for + duplex.
 - “–DUP” or “+DUP” appears to indicate the transmit frequency for minus shift or plus shift, respectively.
- 4) Push and hold [PTT] to transmit.
 - The displayed frequency automatically changes to the transmit frequency (repeater input frequency).
 - When the repeater requires a tone, see section at right.
 - If “o.FF” appears, confirm the offset frequency. (p. 32)
- 5) Release [PTT] to receive.
- 6) Push and hold [MONI] to check whether the other station’s signal on the repeater input frequency can be directly received or not.

Tone information

SUBAUDIBLE TONE

(An optional UT-63 is necessary except for the U.S.A. version.)

- 1) Push [Ⓟ T/P.B/T SQL] to turn ON the subaudible tone encoder.
 - “T” appears.
 - To set the subaudible tone frequency, see the page at right “Subaudible tone.”
- 2) Push [Ⓟ T/P.B/T SQL] 3 times until “T” disappears to turn OFF the subaudible tone encoder.

DTMF TONES

While pushing [PTT], push the desired digit key to transmit DTMF tones.

- DTMF memory is equipped in the transceiver. See p. 45 for details.

1750 Hz TONE (IC-4SRE only)

While pushing [PTT], push and hold [H MAIN] for 1 ~ 2 sec. to transmit a 1750 Hz tone.

Offset frequency USING SET MODE

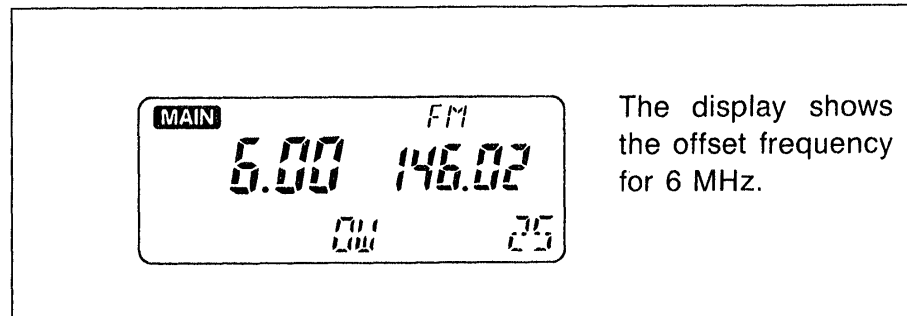

- 1) Push [H MAIN] to select the ham band.
- 2) Push [① V/M] to select VFO mode if another mode has been selected.
- 3) While pushing [F], push [⑧ SET] to enter SET mode.
 - Refer to p. 29 for SET mode details.
- 4) Push [Δ/SCAN] or [▽/SCAN] until "OW" appears as shown above.
- 5) Rotate the main dial to select the desired offset frequency.
 - For quick selection, rotate the main dial while pushing [F].
- 6) Push [⊛ CLR] to exit SET mode.

Subaudible tone USING SET MODE

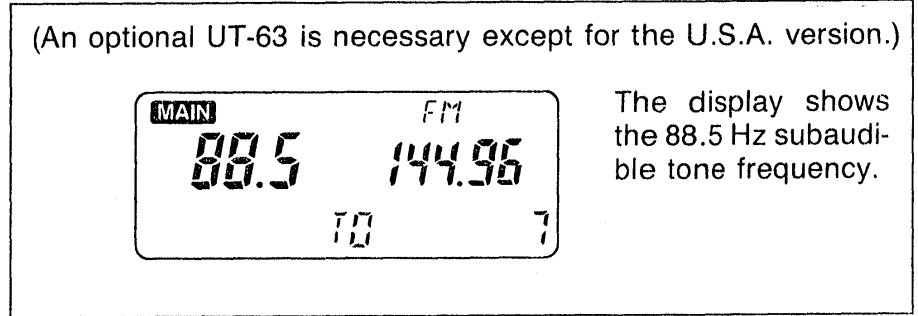

- 1) Push [H MAIN] or [R MAIN] to select the desired band.
- 2) Push [① V/M] to select VFO mode if another mode has been selected.
- 3) While pushing [F], push [⑧ SET] to enter SET mode.
 - Refer to p. 29 for SET mode details.
- 4) Push [Δ/SCAN] or [▽/SCAN] until "TO" appears as shown above.
- 5) Rotate the main dial to select the desired subaudible tone frequency.
- 6) Push [⊛ CLR] to exit SET mode.

67.0	97.4	136.5	192.8
71.9	100.0	141.3	203.5
74.4	103.5	146.2	210.7
77.0	107.2	151.4	218.1
79.7	110.9	156.7	225.7
82.5	114.8	162.2	233.6
85.4	118.8	167.9	241.8
88.5	123.0	173.8	250.3
91.5	127.3	179.9	
94.8	131.8	186.2	(Unit:Hz)

12 SCAN

Scan type

Each band has 5 scan types with skip functions and 2 resume conditions to suit your needs. Scans on both bands can be operated separately or simultaneously.

FULL SCAN

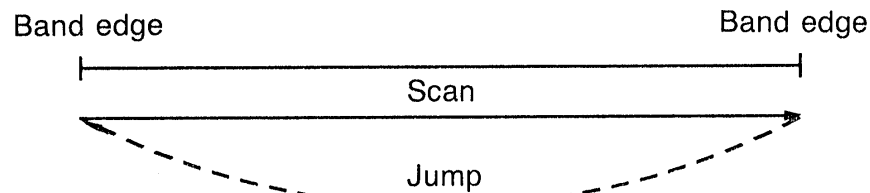

Repeatedly scans all frequencies over the entire selected band.

PROGRAMMED SCAN

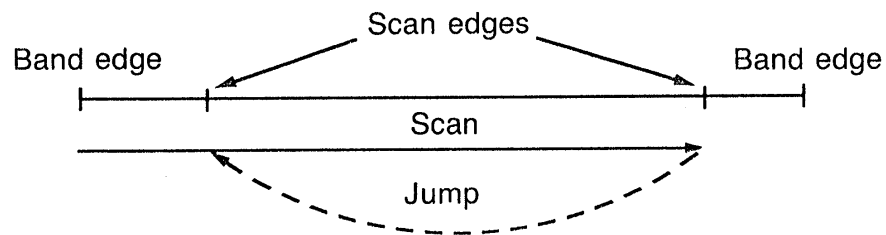

Repeatedly scans between two user-programmed frequencies.

MEMORY SCAN

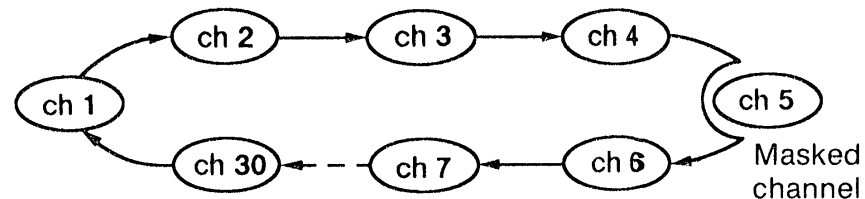

Repeatedly scans all memory channels except masked channels in sequence.

MEMORY SKIP SCAN

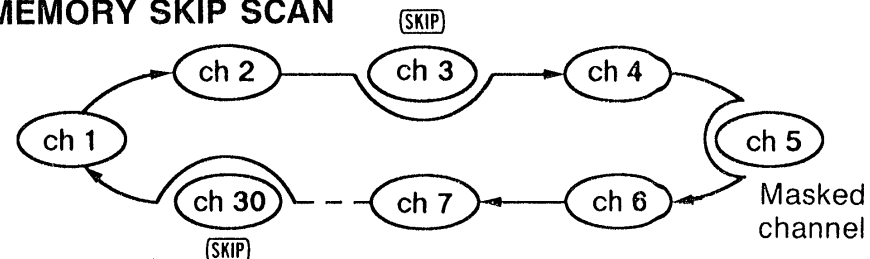

Repeatedly scans memory channels except skip channels and masked channels.

SELECTED MODE MEMORY SCAN (Receiver band only)

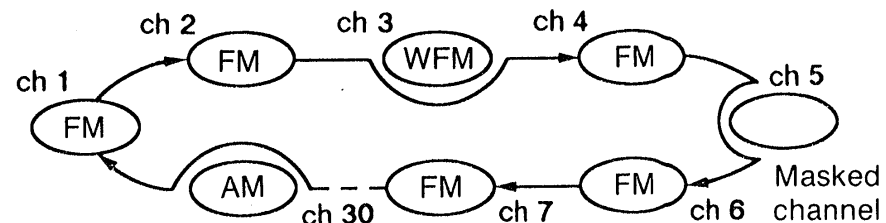

Repeatedly scans memory channels with the same selected receive mode.

Scan operations

Read the following table horizontally for each type of scan; procedures in ①, ④, and ⑤ apply to all scan types.

SCAN TYPE	① PRE-OPERATION 1		② PRE-OPERATION 2	③ SCAN START	④ RESUME CONDITION	⑤ SCAN STOP
FULL SCAN	1) Push [H MAIN] or [R MAIN] to select the band to be scanned. 2) Turn [SQL] until there is no noise. NOTE: When the squelch is too tight, the scan might not stop on a weak signal.	Set tuning step. (p. 21)	Push [① V/M] to select VFO mode.	Push and hold [Δ/SCAN] or [▽/SCAN] for 1 sec.	Rotating the main dial resumes the scan manually and changes the scan direction. When timer scan is selected: Scan resumes 5 sec. after receiving starts. When pause scan is selected: Scan resumes 2 sec. after a received signal disappears. Resume condition can be selected. See p. 35 for details.	Push [Δ/SCAN] or [▽/SCAN]. Pushing [⊗ CLR] also stops the scan.
PRO-GRAMMED SCAN			1) Program the scan edge frequencies. (p. 36) 2) Push [① V/M] to select VFO mode.	While pushing [F], push [Δ/SCAN] or [▽/SCAN].		
MEMORY SCAN			Push [① V/M] to select MEMORY mode.	Push and hold [Δ/SCAN] or [▽/SCAN] for 1 sec.		
MEMORY SKIP SCAN			1) Push [① V/M] to select MEMORY mode. 2) Set the undesired channels as skip channels. (p. 38)	While pushing [F], push [Δ/SCAN] or [▽/SCAN].		
SELECTED MODE MEMORY SCAN			Push [R MAIN] to select the receiver band.	1) Push [① V/M] to select MEMORY mode. 2) Select the desired receive mode.		

12 SCAN

■ Scan resume condition

The scan resume condition can be selected as a pause scan or timer scan. The resume condition is not only used for scans but also for priority watches.

Pause scan: When the operating scan detects a signal, the scan pauses on the frequency until the signal disappears and resumes 2 sec. later.

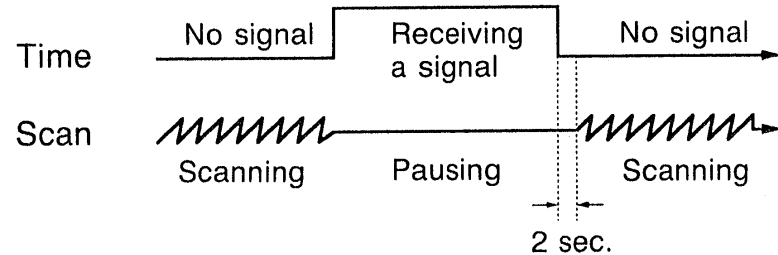

Timer scan: When the operating scan detects a signal, the scan resumes after pausing on the frequency for 5 sec.

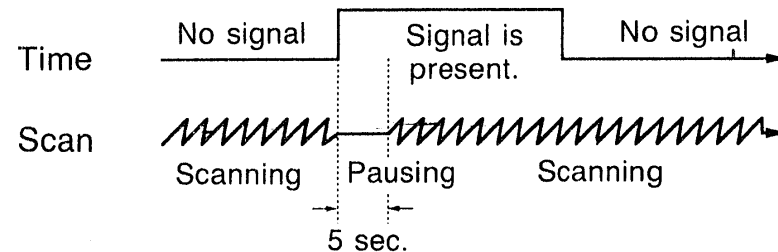

USING SET MODE

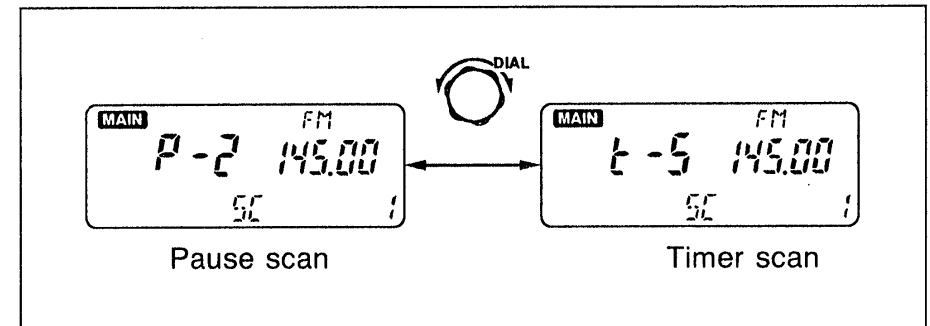

- 1) Push [H MAIN] or [R MAIN] to select the desired band.
- 2) Push [① V/M] to select VFO mode if another mode has been selected.
- 3) While pushing [F], push [⑧ SET] to enter SET mode.
 - Refer to p. 29 for SET mode details.
- 4) Push [Δ/SCAN] or [▽/SCAN] until "SC" appears as shown above.
- 5) Rotate the main dial to select the desired resume condition.
- 6) Push [⊛ CLR] to exit SET mode.

■ Programming scan edges

Scan edges can be programmed in the same way as memory channels. Memory channels "PA" and "PB" are available for programming scan edges.

- 1) Push [H MAIN] or [R MAIN] to select the desired band.
- 2) Select the scan edge memory channel "PA" or "PB":
 - Push [① V/M] to select MEMORY mode. ("M" appears).
 - Rotate the main dial to select memory channel "PA" or "PB."
- 3) Set the scan edge frequencies in VFO mode.
 - Push [① V/M] to select VFO mode.
 - Set the desired frequency to be programmed into the memory channel.
- 4) While pushing [F], push and hold [① MW] until the transceiver emits 3 beeps.
- 5) To program a frequency for the other scan edge memory channel "PB" or "PA," repeat steps 2~4.
 - If the same frequency is programmed into "PA" and "PB," programmed scan will not function.

Refer to the diagram on p. 26 for programming.

[EXAMPLE]: Programming 434.500 MHz into the scan edge PA.

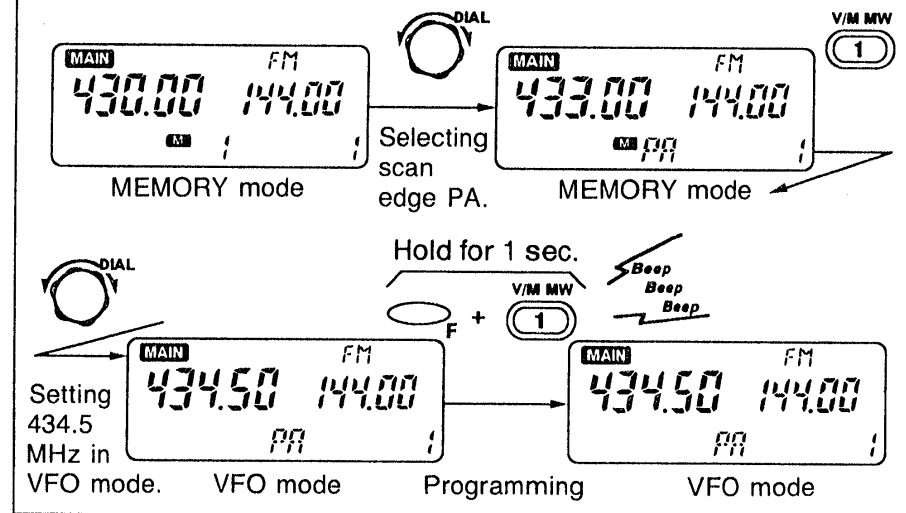

CONVENIENT

- Scan edge memory channels can program a frequency with tone information, duplex information, etc. in the same way as memory channels.
- Scan edge memory channels can be masked in the same way as memory channels. Even if the scan edge memory channels are masked, programmed scan can be operated and masked frequencies are available for the scan.

12 SCAN

■ Frequency skip function

This function skips unwanted frequencies that inconveniently stop scanning during full or programmed scan.

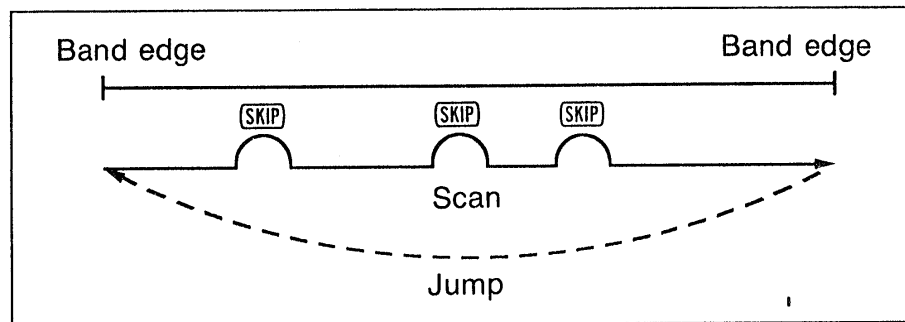

To program skip frequencies, designate the frequency as a skip frequency when full or programmed scan is pausing on the frequencies. See right for programming.

You can also program skip frequencies before starting the scan. Program the frequencies that you know in advance into memory channels with skip information. For programming, refer to p. 38 "Setting a skip memory channel."

• Programming skip frequencies

This is the way to program the skip frequency when full or programmed scan is in the pause condition.

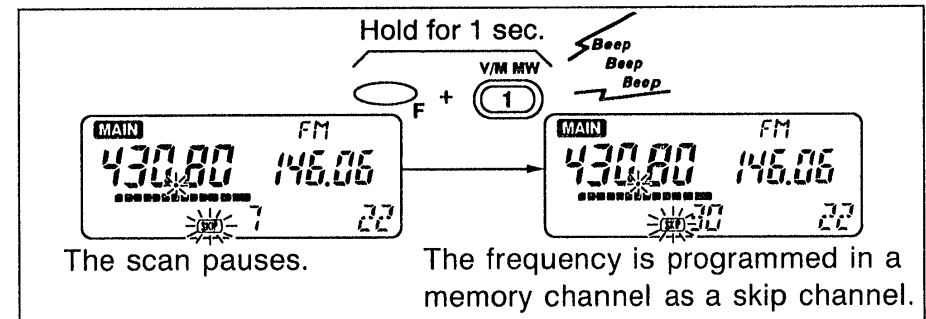

- 1) Turn ON the frequency skip function.
 - After resetting, the function is automatically turned ON.
 - To turn the function ON or OFF, see "Activating" on p. 38.
- 2) Start the full scan or the programmed scan. (p. 34)
- 3) Program the received frequency as the skip frequency when scan is paused.
 - While pushing [F], push [① V/M] for 1 sec.
 - Masked memory channels are used in reverse sequence 60~10*.
 - If all memory channels 60~10* are programmed and are not masked, this programming procedure cannot be operated.

*30~10 for the ham band.

• Activating

(Frequency skip function ON/OFF)

USING SET MODE

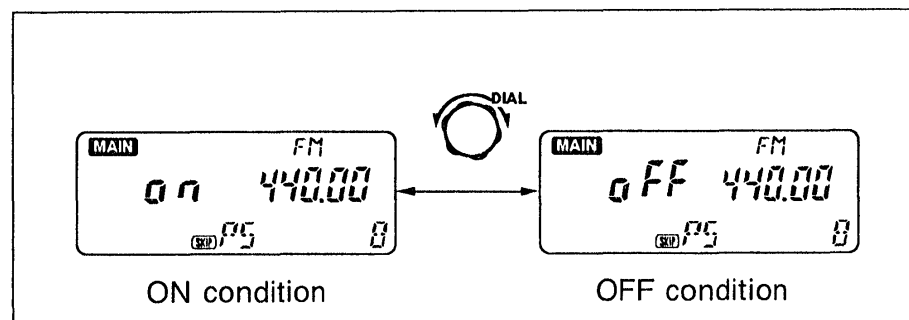

- 1) Push [H MAIN] or [R MAIN] to select the desired band.
- 2) Push [① V/M] to select VFO mode if another mode has been selected.
- 3) While pushing [F], push [⑧ SET] to enter SET mode.
 - Refer to p. 29 for SET mode details.
- 4) Push [Δ/SCAN] or [▽/SCAN] until "SKIP PS" appears as shown above.
- 5) Rotate the main dial to turn the function ON or OFF.
- 6) Push [⊛ CLR] to exit SET mode.

■ Setting a skip memory channel

Program skip memory channels before starting memory skip scan. While the scan is activated, you cannot program skip memory channels.

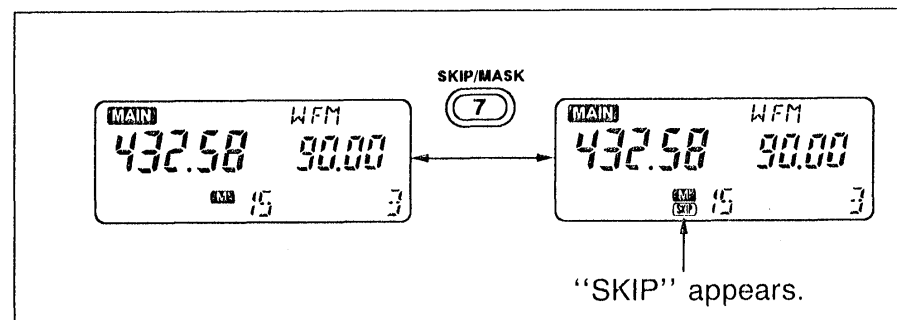

- 1) Select the memory channel to be programmed as the skip channel.
 - Push [① V/M] to select MEMORY mode.
 - Rotate the main dial to select the desired memory channel.
- 2) Push [⑦ SKIP] to set the memory channel to the skip channel.
 - "SKIP" disappears.
- 3) Repeat the above steps to delete the skip information from the memory channel.
 - "SKIP" disappears.

NOTE: The memory channel programmed as the skip channel is effective for the frequency skip function.

13 PRIORITY WATCH

■ Priority watch types

MEMORY CHANNEL WATCH

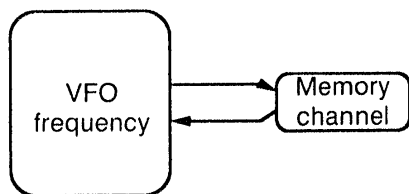

While operating in a VFO frequency, priority watch checks the selected memory channel every 5 sec.

- When the selected memory channel is masked (hidden), the watch does not start.

MEMORY SCAN WATCH

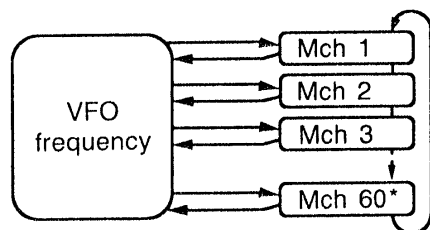

*Mch 30 for the ham band.

While operating in a VFO frequency, priority watch checks each memory channel in sequence.

- The memory skip scan can be used for shorter scanning intervals. See p. 38 for memory skip scan details.

CALL CHANNEL WATCH

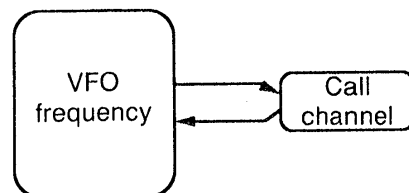

While operating in a VFO frequency, priority watch checks the call channel every 5 sec.

■ Operation

- 1) Push [H MAIN] or [R MAIN] to select the desired band.
- 2) Turn [SQL] until there is no noise.
 - When the squelch is set too far clockwise, priority watch might not stop on a weak signal.
- 3) Set the channel to be watched:
 - For memory channel watch, select the memory channel with the main dial in MEMORY mode.
 - For call channel watch, push [④ CALL] to select the call channel.
 - For memory scan watch, push and hold [Δ/SCAN] or [▽/SCAN] in MEMORY mode to start memory scan.
- 4) Push [Ⓧ PRIO] to start priority watch.
 - When receiving a signal on the channel being watched, priority watch pauses for 5 sec. or until the signal disappears. See "Scan resume condition" on p. 35 for details.
 - While the watch pauses, pushing [Ⓧ PRIO] will disengage the pause and resume the watch.
- 5) Push [Ⓧ PRIO] while the display shows the operating frequency to stop the priority watch.

■ Clock mode

The transceiver has a built-in 24-hour clock with power-on and power-off timer functions.

Both the ham and receiver bands have a clock display. But, clock and timer settings are available only when the ham band is selected as the main band.

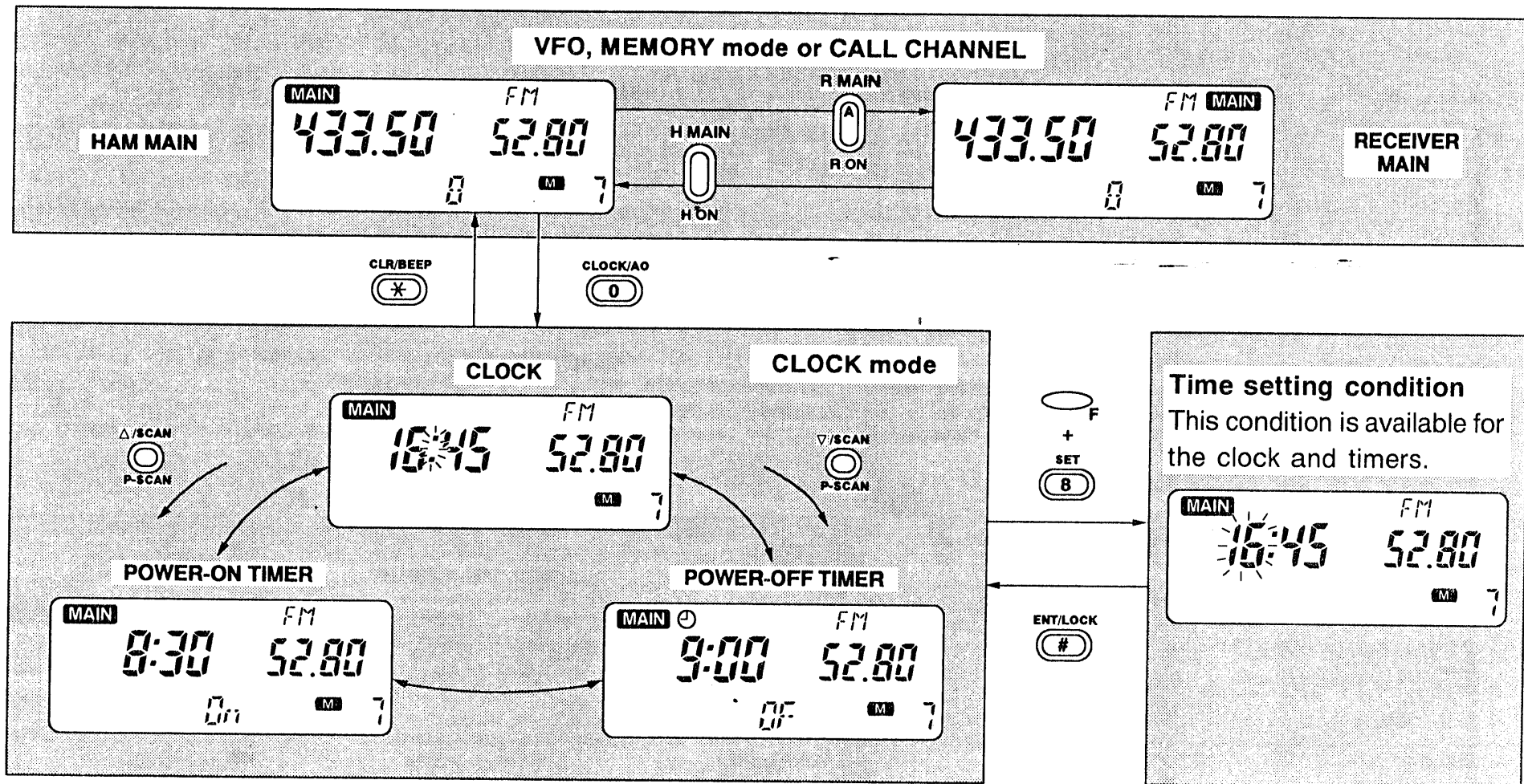

14 CLOCK AND TIMER

■ Clock operation

• Setting the time

Only the ham band can be used for clock setting.

1) Select CLOCK mode:

- Push [H MAIN] to select the ham band.
- Push [CLOCK] to enter CLOCK mode.

2) Set the time:

- While pushing [F], push [SET] to set the transceiver in the time-setting condition.
- Rotate the main dial to set the hour.
- Push [Δ/SCAN] or [▽/SCAN], then rotate the main dial to set the minute.
- When a wrong time is set, push [CLR] and begin step 2 again.
- Push [ENT] to enter the time.

3) Exit CLOCK mode.

- Push [CLR].

• Clock indication

1) To display the clock, push [CLOCK].

- On both the ham and receiver bands, the clock can be indicated.
- Transmitting and receiving are possible even when the clock display is indicated on the receiver band.

2) To make the clock disappear, push [CLR].

TIME ERROR: ± 1 min./week

NOTE: CPU resetting clears the clock time. Set the time again, if desired.

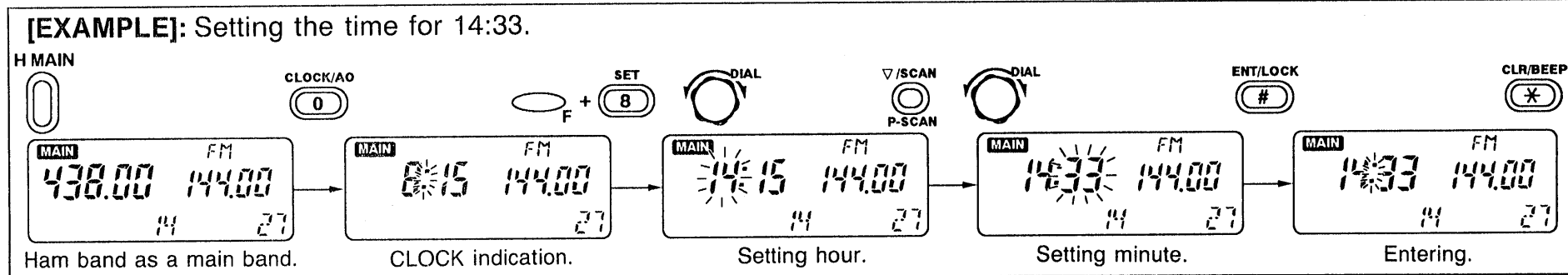

■ Power-on timer

• Power-on timer operation

The transceiver has a power-on timer to suit your schedule and conserve battery power.

- 1) Push [H MAIN] to select the ham band, push [⓪ CLOCK] to select CLOCK mode.
- 2) Push [Δ/SCAN] to select the power-on display.
- 3) While pushing [F], push [⑦ MASK] to recall the previously set time.
- 4) Set the power-on time.
 - See “Setting power-on time” at right for setting the time.
- 5) Push and hold [POWER] to turn power OFF.
 - When the set time arrives, the power is automatically turned ON with 5 beeps.
 - Once power is turned ON by this timer, the set time is automatically masked.
- 6) To cancel the power-on timer, mask the set time.
 - Repeat steps 1~3.

• Setting power-on time

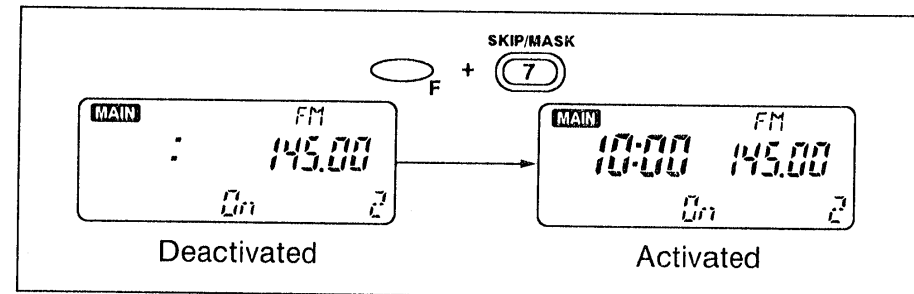

- 1) Push [H MAIN] to select the ham band, then push [⓪ CLOCK] to select CLOCK mode.
- 2) Push [Δ/SCAN] to select the power-on display.
- 3) While pushing [F], push [⑦ MASK] to recall the previously set time when the time is not indicated.
- 4) While pushing [F], push [⑧ SET] to set the transceiver in the time-setting condition.
- 5) Rotate the main dial to set the hour, then push [Δ/SCAN] or [▽/SCAN], and rotate the main dial to set the minute.
- 6) Push [Ⓝ ENT] to enter the time.
- 7) Push [Ⓚ CLR] to exit CLOCK mode.

14 CLOCK AND TIMER

■ Power-off timer

• Power-off timer operation

The transceiver has a power-off timer separate from the auto power-off function (p. 47) to turn power OFF at the preset time.

- 1) Push [H MAIN] to select the ham band, then push [⓪ CLOCK] to select CLOCK mode.
- 2) Push [▽/SCAN] to select the power-off display.
- 3) While pushing [F], push [⑦ MASK] to recall the previously set time.
 - “Ⓜ” appears.
- 4) Set the power-off time.
 - See “Setting power-off time” at right for setting the time.
- 5) Push [⊛ CLR] to exit CLOCK mode.
 - When the set time arrives, the power is automatically turned OFF with 5 beeps.
 - Once the power is turned OFF by this timer, the set time is automatically masked.
- 6) To cancel the power-off timer, mask the set time.
 - Repeat steps 1 ~ 3.

• Setting power-off time

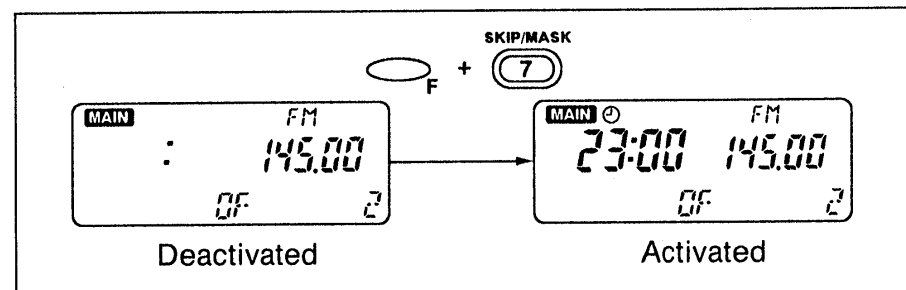

- 1) Push [H MAIN] to select the ham band, then push [⓪ CLOCK] to select CLOCK mode.
- 2) Push [▽/SCAN] to select the power-off display.
- 3) While pushing [F], push [⑦ MASK] to recall the previously set time when the time is not indicated.
- 4) While pushing [F], push [⑧ SET] to set the transceiver in the time-setting condition.
- 5) Rotate the main dial to set the hour, then push [△/SCAN] or [▽/SCAN], and rotate the main dial to set the minute.
- 6) Push [⊞ ENT] to enter the time.
- 7) Push [⊛ CLR] to exit CLOCK mode.

[EXAMPLE]: Setting the power-off timer time to 17:30.

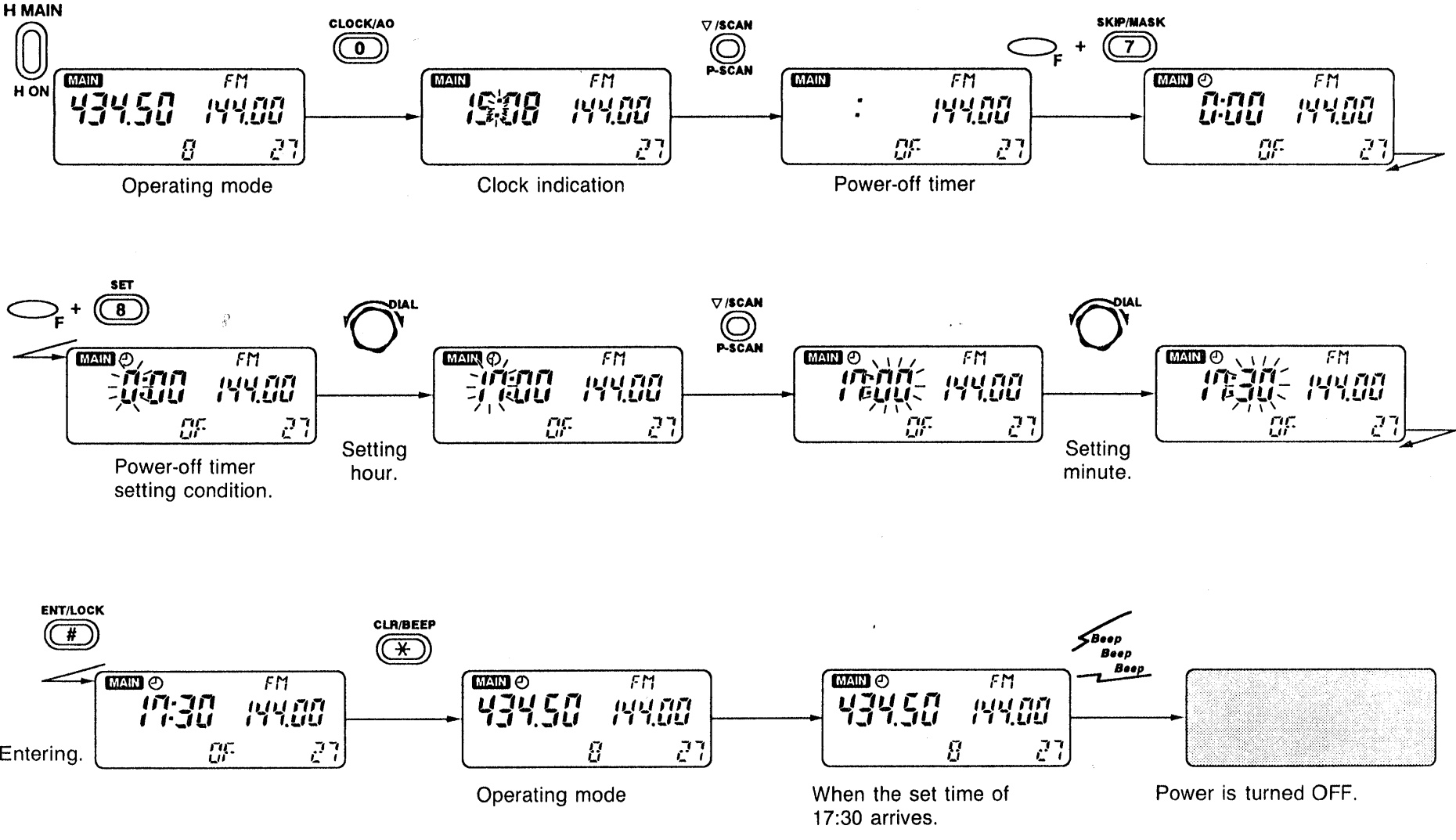

15 DTMF MEMORY

□ General description

The transceiver has 4 DTMF memory channels for storage of often-used DTMF codes of up to 15 digits such as telephone numbers for autopatching.

Only the ham band can be used for programming.

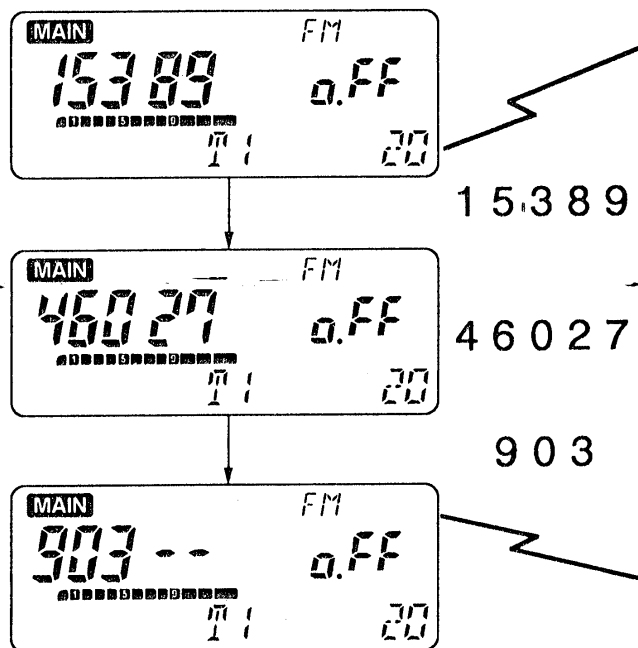
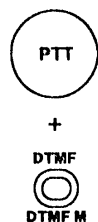

The programmed DTMF code is transmitted.

The function display automatically shows the sending DTMF digits in the sequence of their transmission.

NOTE: Manual DTMF transmission is also possible. While pushing [PTT], push the key of the desired DTMF digit. (1~0, A~D, * and # are available.)

□ Transmitting a DTMF code

The programmed DTMF code can be transmitted on the ham band. On the receiver band the programmed DTMF code can be emitted from the speaker but cannot be transmitted.

- 1) Push [H MAIN] to select the ham band.
- 2) While pushing [F], push [DTMF M] to select DTMF MEMORY mode.
- 3) Rotate the main dial to select the desired DTMF memory channel.
 - To program the DTMF code into a DTMF memory channel, see "Programming a DTMF code" at right.
- 4) Push [⊛ CLR] to exit DTMF MEMORY mode.
- 5) While pushing [PTT], push [DTMF] to transmit a DTMF code.
 - Pushing [DTMF] without [PTT] emits the DTMF code of the selected DTMF memory channel from the speaker.

□ Programming a DTMF code

- 1) Push [H MAIN] to select the ham band.
- 2) While pushing [F], push [DTMF M] to select DTMF MEMORY mode.
- 3) Rotate the main dial to select the desired DTMF memory channel to be programmed.
- 4) While pushing [F], push [Ⓢ SET] to set the transceiver in the DTMF programming condition.
 - Previously programmed digits are erased.
- 5) Push the appropriate digit keys to input the DTMF code.
 - When entering a wrong digit, push [DTMF] and start again from step 4.
- 6) Push [DTMF] to store the entered digits.
- 7) When programming another DTMF memory channel, repeat steps 3~6.
- 8) Push [⊛ CLR] to exit DTMF MEMORY mode.

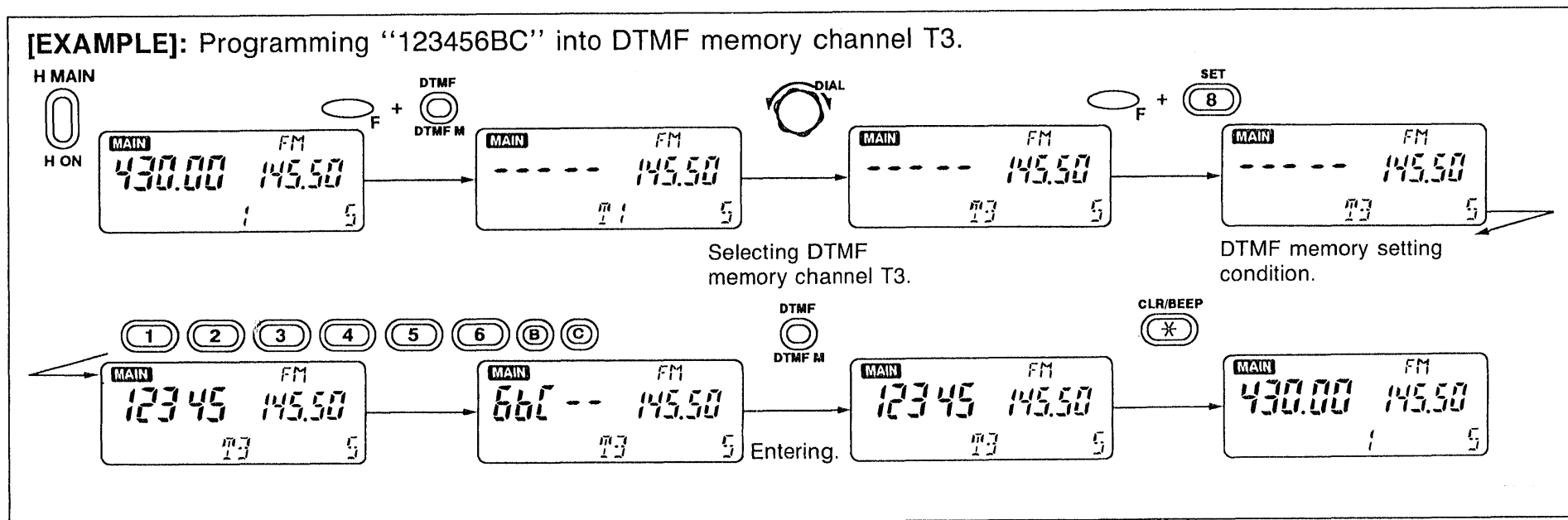

16 POWER SAVER

■ Power saver

USING SET MODE

The power saver function reduces the current drain to conserve battery power. The duty cycle of the power saver can be selected and can be turned ON or OFF.

Standby: 125 msec. Circuit off: 500 msec.	125 msec. 2 sec.	Power saver is turned OFF.

- 1) Push [H MAIN] or [R MAIN] to select the desired band.
- 2) Push [① V/M] to select VFO mode if another mode has been selected.
- 3) While pushing [F], push [⑧ SET] to enter SET mode.
 - Refer to p. 29 for SET mode details.
- 4) Push [Δ/SCAN] or [▽/SCAN] until "PD" appears as shown above.
- 5) Rotate the main dial to select the desired duty cycle or to turn the function OFF.
- 6) Push [* CLR] to exit SET mode.

■ Auto power-off

The transceiver automatically turns OFF after a selected period in which no switch is pushed or no signal is received. Only the ham band can be used for setting this period.

Auto power-off is not activated.	Auto power-off period of 30 min.	Auto power-off period of 60 min.

- 1) Select the auto power-off display:
 - While pushing [F], push [Ⓞ AO]. Continue holding [F] until step 2 is completed.
- 2) Select the auto power-off period.
 - While holding [F], rotate the main dial.
 - 60 min., 30 min. and OFF can be selected.
 - Release [F].
- 3) When the set period passes, the transceiver is automatically turned OFF with 5 beeps.

NOTE: The selected period is retained even when the transceiver is turned OFF by auto power-off. To cancel the function, select "oFF" in step 2 above.

■ Display lighting

The transceiver has a display backlight for night operation. The lighting continues for 5 sec., and continuous lighting is also possible.

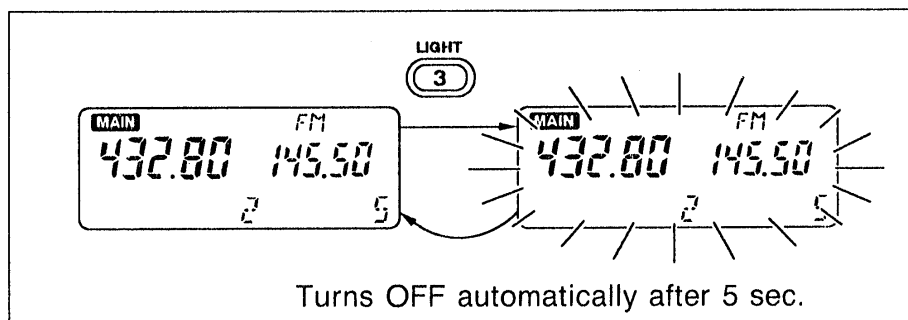

To activate lighting for 5 sec.:

Push [③ LIGHT].

- Lighting activates for 5 sec. and then automatically turns OFF.

To activate continuous lighting:

- 1) While pushing [F], push [③ LIGHT].
- 2) To turn lighting OFF, push [③ LIGHT].

NOTE: Continuous lighting remains activated even if the power is turned OFF and ON again.

■ One-band operation

The band that is not necessary for receiving can be turned OFF. One-band operation conserves battery power by turning OFF the circuit of the band not displayed.

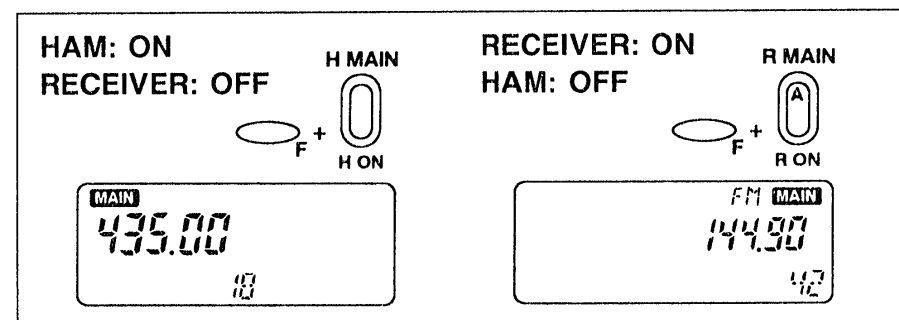

While pushing [F] on the side panel, push [H ON] or [R ON].

■ Beep tone

The beep tone emitted each time a switch is pushed can be turned OFF.

While pushing [F], push [⊛] BEEP to turn OFF and ON the beep.

NOTE: Even if the beep is OFF, the transceiver emits a beep tone for auto power-off, the power on/off timer, the pager and optional* pocket beep functions.

*Built-in to the U.S.A. version.

17 PAGER AND CODE SQUELCH

■ General description

• Pager

The pager function is a selective calling system using DTMF digits. With the pager, you can call any one or all the stations in your group, and you can receive a specified call from a station in your group. To use the pager function in your group, all stations need the pager function.

The transmit station sends a code consisting of a transmit code and the transmit station's ID code. If the transmit code matches the code programmed in the code channel of the receive station, the transceiver in the receive station informs the operator with beeps. For a personal call, the ID code of the receive station is used as the transmit code. For a group call, the group code is used as the transmit code.

The pager code for a call =

Transmit code + "*" + Transmit station's ID code.

The receive station can recognize the transmit station by the received ID code of the transmit station and can easily answer back because the received ID code is automatically programmed as a transmit code for answer back.

The pager code for answer back =

Received ID code + "*" + Receive station's ID code.

During pager or code squelch operation, the power saver duty rate becomes 1:1 if the power saver is activated.

[PAGER SIMULATION]: Personal call

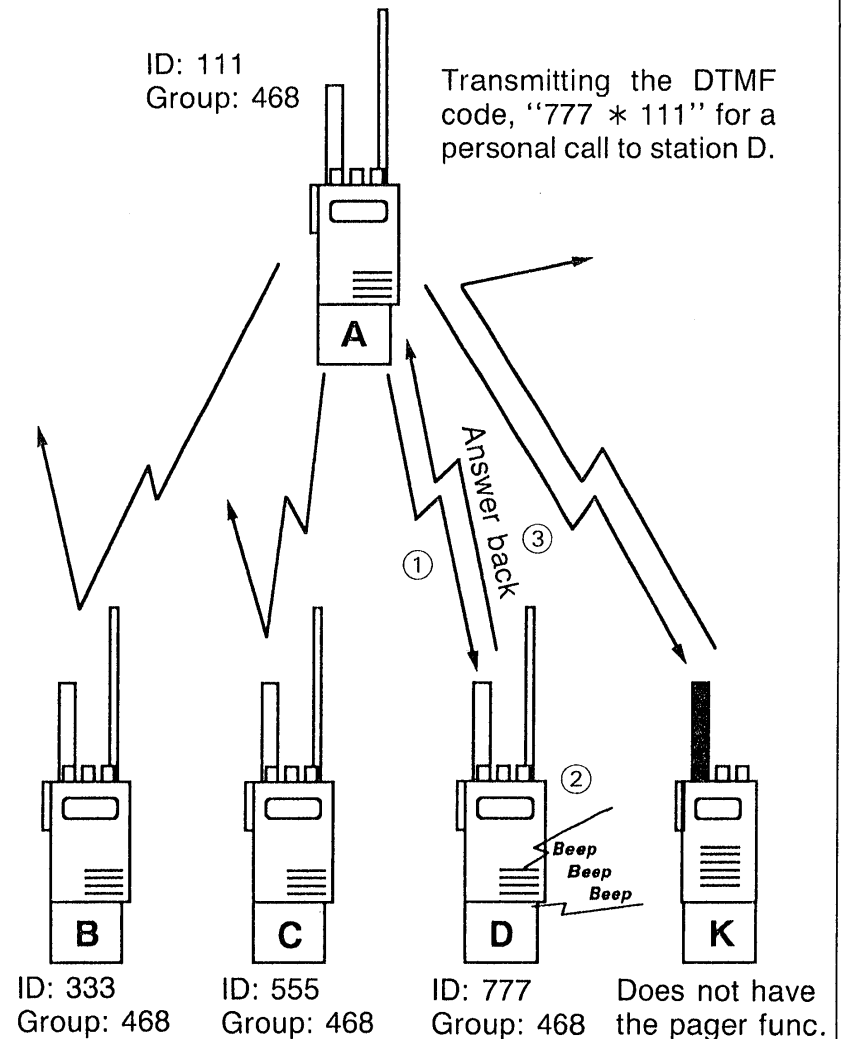

[PAGER SIMULATION]: Group call

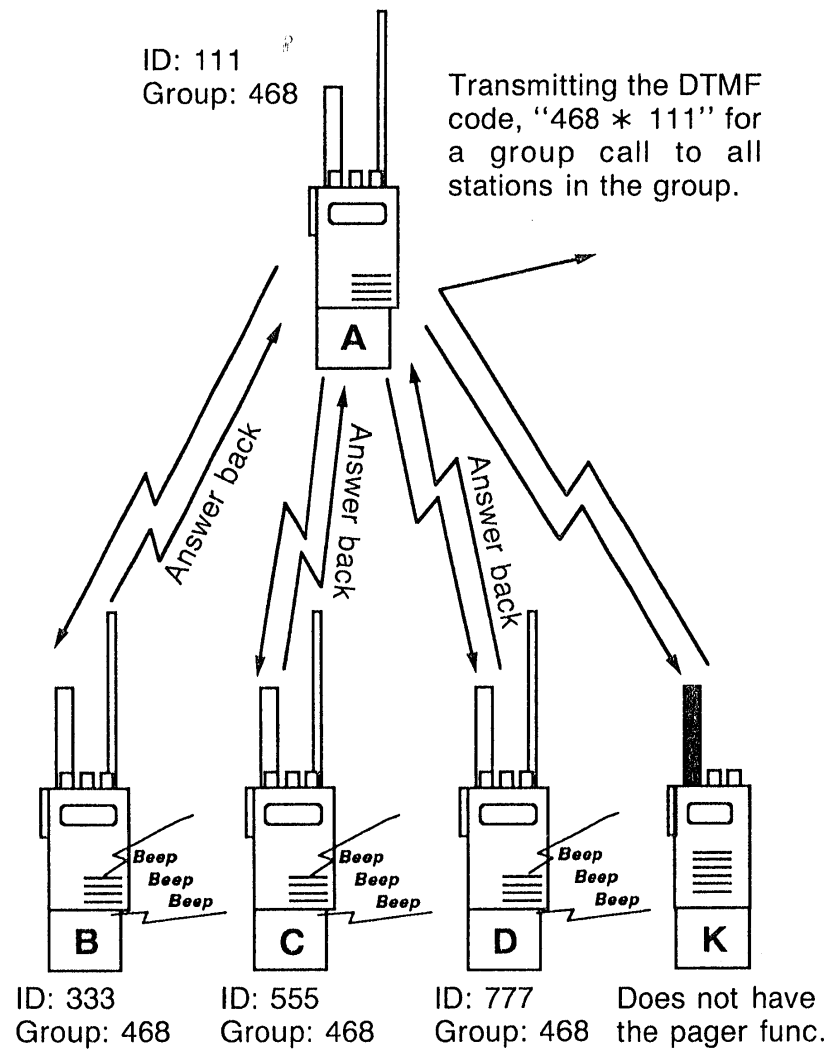

• **Code squelch**

Code squelch allows communication and quiet standby since you will only receive calls from stations which know your ID code.

Prior to voice transmission, the ID code of the transmitting stations is transmitted in order to open the receiving station's code squelch.

[CODE SQUELCH SIMULATION]

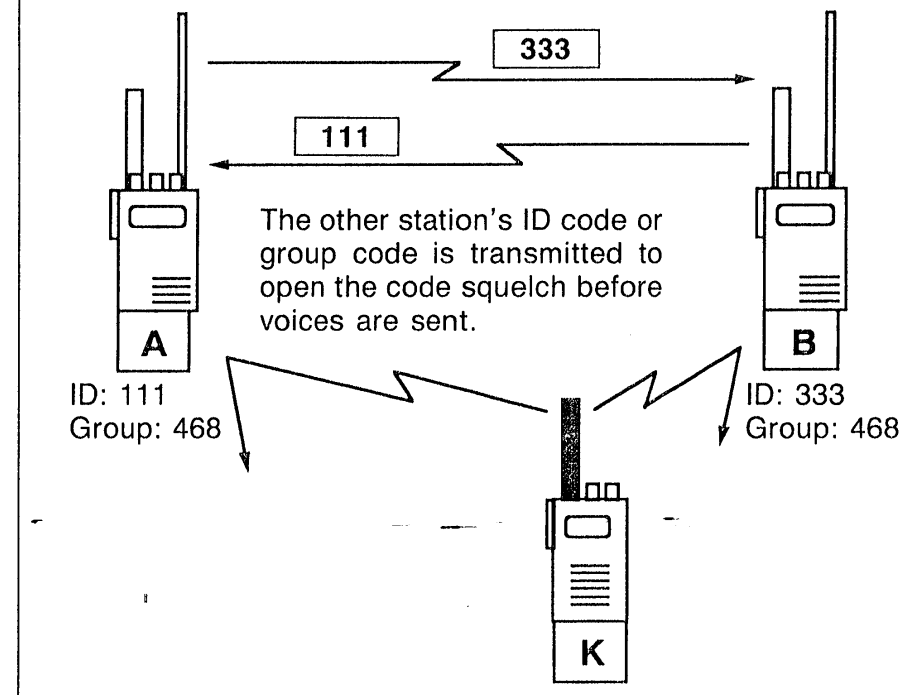

■ Code channel

• Before programming

The pager and code squelch functions require ID codes and a group code. These codes are 3-digit DTMF codes and must be written in the code channels before operation.

• Code channel assignment

ID or group code	Code channel number	“Receive accept” or “Receive inhibit”
Your ID code	C0	“Receive accept” only.
Other station’s ID code	C1 ~ C5	“Receive inhibit” should be programmed in each channel
Group code	One of C1 ~ C5	“Receive accept” must be programmed.
Memory space*	CP	“Receive inhibit” only.

*Channel CP automatically memorizes an ID code when receiving a pager call. The contents in channel CP cannot be changed.

Both the ham and receiver bands have separate code channels, C0 ~ C5 and CP.

“RECEIVE ACCEPT” OR “RECEIVE INHIBIT”

Code channels C1 ~ C5 should be effectively programmed as “Receive accept” or “Receive inhibit.”

- “Receive accept” (“SKIP” indicator is not illuminated) accepts pager calls when the transceiver receives a signal with a code the same as that in the code channel.
- “Receive inhibit” (“SKIP” indicator is illuminated) rejects calls when the transceiver receives a signal with a code the same as that in the code channel.

For example, the code channel that stores the group code should be programmed as “Receive accept.” If the channel is programmed as “Receive inhibit,” you cannot receive group calls.

The code channels that store other station’s ID code for a transmit code should be programmed as “Receive inhibit.” If the channels are programmed as “Receive accept,” the personal call for other stations that you don’t need will be received.

• **Programming**

- 1) Push [H MAIN] or [R MAIN] to select the desired band to be programmed.
 - The ham and receiver bands have separate code channels.
- 2) While pushing [F], push [Ⓒ CODE] to select the code channel setting display.
- 3) Rotate the main dial to select the desired code channel.
- 4) Push numeral keys to enter the desired digit codes.
 - Digits are automatically stored once the 3rd digit has been entered.
 - When a wrong digit is entered, push [⊗ CLR] and begin step 4 again.
- 5) Push [Ⓒ PGR/CODE] to set the code channel for “Receive inhibit” (“SKIP” is illuminated) or “Receive accept” (“SKIP” is not illuminated).
 - See the box on p. 51 for “Receive accept” and “Receive inhibit” details.
- 6) Push the selected band switch, [H MAIN] or [R MAIN], to exit the setting display.

[GROUP PROGRAMMING EXAMPLE]

(Group code: 468)

	Code channel	Code	“Receive accept” or “Receive inhibit”	Comment
STATION A (ID: 111)	C0	111	“Receive accept”	ID
	C1	333	“Receive inhibit”	ID of station B
	C2	555	“Receive inhibit”	ID of station C
	C3	777	“Receive inhibit”	ID of station D
	C4	000	“Receive inhibit”	Non-use
	C5	468	“Receive accept”	Group code

	Code channel	Code	“Receive accept” or “Receive inhibit”	Comment
STATION B (ID: 333)	C0	333	“Receive accept”	ID
	C1	555	“Receive inhibit”	ID of station C
	C2	777	“Receive inhibit”	ID of station D
	C3	111	“Receive inhibit”	ID of station A
	C4	000	“Receive inhibit”	Non-use
	C5	468	“Receive accept”	Group code

	Code channel	Code	“Receive accept” or “Receive inhibit”	Comment
STATION C (ID: 555)	C0	555	“Receive accept”	ID
	C1	777	“Receive inhibit”	ID of station D
	C2	111	“Receive inhibit”	ID of station A
	C3	333	“Receive inhibit”	ID of station B
	C4	000	“Receive inhibit”	Non-use
	C5	468	“Receive accept”	Group code

	Code channel	Code	“Receive accept” or “Receive inhibit”	Comment
STATION D (ID: 777)	C0	777	“Receive accept”	ID
	C1	111	“Receive inhibit”	ID of station A
	C2	333	“Receive inhibit”	ID of station B
	C3	555	“Receive inhibit”	ID of station C
	C4	000	“Receive inhibit”	Non-use
	C5	468	“Receive accept”	Group code

17 PAGER AND CODE SQUELCH

□ Pager operation

Prior to operation, decide whether communication after the connection will take place with or without code squelch. Only the ham band can be used for pager operation.

• Calling a specific station

To call a specific station, use the ID code of that station as the transmit code. To call all stations in your group, use the group code as the transmit code.

(PAGER CODE: Transmit code + "*" + your ID code)

- 1) Push [H MAIN] to select the ham band.
- 2) Set the frequency.
- 3) Push [©PGR/C SQL] to turn the pager function ON.
 - "PGR" appears.

- 4) Select a code channel which includes the ID code of the receive station or the group code to be used as a transmit code.
 - While pushing [F], push [©CODE].
 - Rotate the tuning control to select the code channel.
 - Push [H MAIN] to exit the setting display.

- 5) Push [PTT] to transmit the pager code.
- 6) Wait for an answer back.
 - When the transceiver receives an answer back code, the function display shows the ID of the receive station.
- 7) After confirming a connection, push [H MAIN] to display the operating frequencies.
- 8) Push [©PGR/C SQL] once to select the code squelch or twice to select the non-selective calling system.

[EXAMPLE]: Selecting the code channel C4.

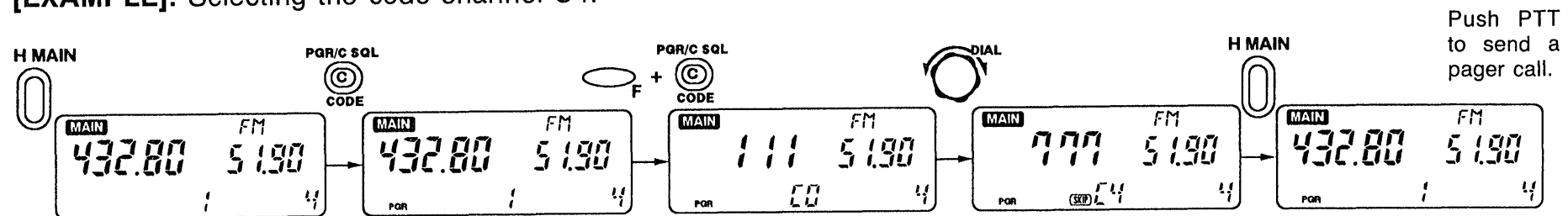

• Waiting for a call from a specific station

- 1) Push [H MAIN] to select the ham band.
- 2) Set the frequency.
- 3) Push [Ⓢ PGR/C SQL] to turn the pager function ON.
 - "PGR" appears.
- 4) Once a call with the correct code is received, the transceiver emits a beep and the function display shows the code as shown at right.
- 5) Push [PTT] to send an answer back call.
 - The display shows the operating frequency.
- 6) Push [Ⓢ PGR/C SQL] once to select the code squelch or twice to select the non-selective calling system.

PERSONAL CALL

This example shows the display which appears when you are called with your ID code and calling station's ID code is 111.

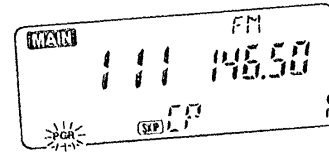

GROUP CALL

This example shows the display which appears when you are called with the group code, 468, and 468 has been programmed into code channel C5.

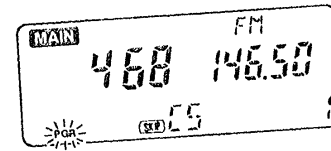

ERROR INFORMATION

When the transceiver receives an incomplete signal, "E" appears.

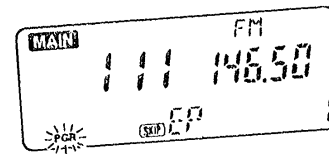

[PAGER OPERATION PROCEDURE EXAMPLE]

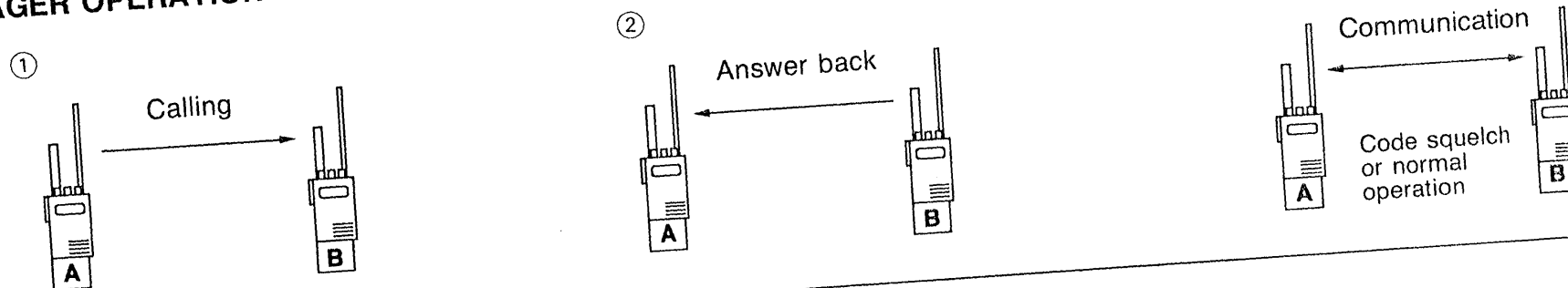

■ Code squelch operation

Code squelch is a selective calling communication system using a transmit code programmed in a code channel. It is convenient after the calling with the pager.

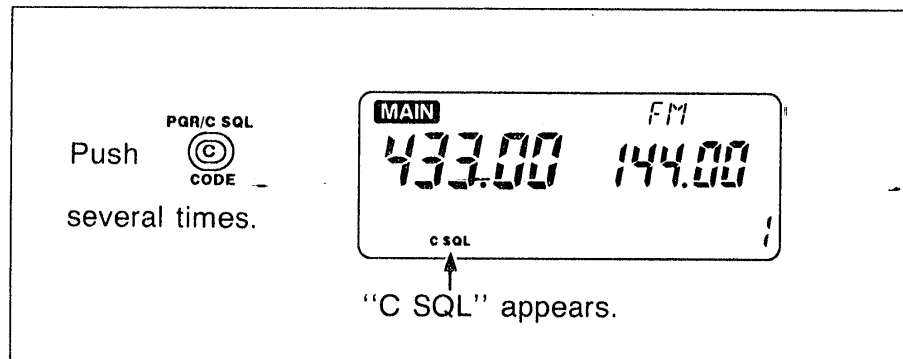

• After the calling with the pager:

The transmit code is automatically set.

- 1) Push [**Ⓢ**PGR/C SQL] once to turn code squelch ON.
 - "C SQL" appears.
- 2) Operate the transceiver in the normal way (push [PTT] to transmit; release [PTT] to receive).
 - Transmit code is sent each time [PTT] is pushed.
- 3) To cancel the code squelch, push [**Ⓢ**PGR/C SQL].

• Using code squelch without the pager:

Transmit code selection is necessary.

- 1) Push [H MAIN] or [R MAIN] to select the desired band.
 - The receiver band can be used only for receiving with code squelch.
 - Code squelch cannot be turned ON simultaneously in the ham and receiver band.
- 2) Push [**Ⓢ**PGR/C SQL] twice to turn code squelch ON.
 - "C SQL" appears.
- 3) Select the code channel which contains the ID code of the other station or group code:
 - While holding [F], push [**Ⓢ**CODE].
 - Rotate the main dial to select the code channel.
 - Push the selected band switch, [H MAIN] or [R MAIN], to exit the setting display.
- 4) Operate the transceiver in the normal way (push [PTT] to transmit; release [PTT] to receive).
 - Transmit code is sent each time [PTT] is pushed.
- 5) To cancel code squelch, push [**Ⓢ**PGR/C SQL].
 - "C SQL" disappears.

■ General description

These two functions are built into to the U.S.A. version. An optional UT-63 TONE SQUELCH UNIT is necessary for other versions.

• Pocket beep

The pocket beep function is a selective calling system using a subaudible tone. If your transceiver receives a subaudible tone that matches the tone programmed in your transceiver, beeps are emitted for up to 30 sec. to alert you.

To call a station with the pocket beep function, transmit a subaudible tone that matches the tone of the receiving station. (Receiving station must also have the pocket beep function).

• Tone squelch

Tone squelch is used for private communication and allows quiet standby since you will receive calls only from stations which know the subaudible tone frequency programmed in your transceiver. You can use tone squelch simultaneously with the pager or code squelch.

The subaudible tone is superimposed with your transmitting voice signal while you are pushing [PTT] in order to open the tone squelch of the receive station.

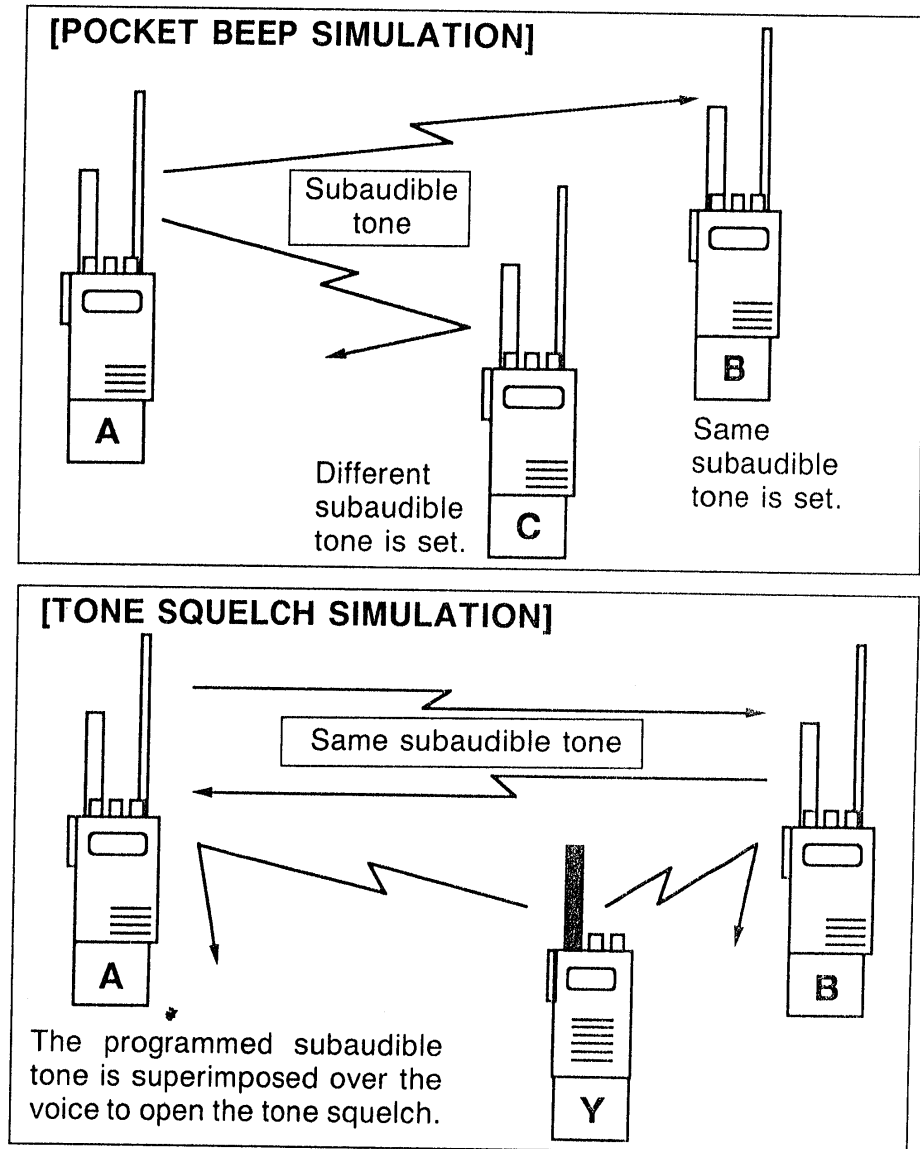

18 POCKET BEEP AND TONE SQUELCH

■ UT-63 installation

The UT-63 is built into the IC-4SRA U.S.A. version. For other versions, an optional UT-63 must be purchased separately.

- 1) Turn the power OFF, then remove the battery pack from the transceiver.
- 2) Unscrew 5 screws from the rear of the transceiver.
- 3) Unscrew 2 screws from the side of the transceiver.
- 4) Remove the rear panel.
- 5) Pull out the terminal board.
- 6) Install and plug the UT-63 as shown in the diagram at right.
- 7) Replace the terminal board and rear panel.
- 8) Replace and tighten the 7 screws.

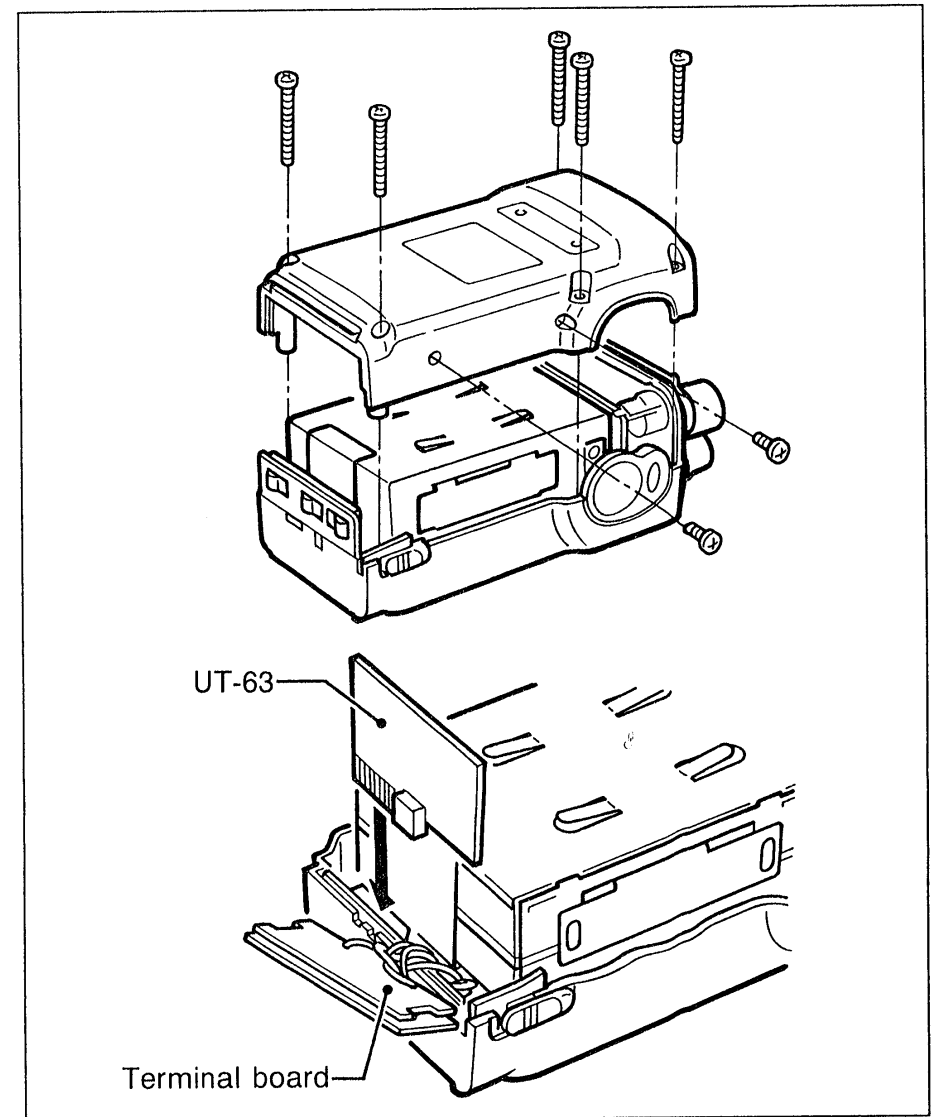

■ Pocket beep operation

• Waiting for a call from a specific station

- 1) Program the subaudible tone frequency in SET mode.
 - See p. 32 for programming details.
- 2) Push [ⓅT/P.B/T SQL] several times until "T SQL (••)" appears on the function display.
- 3) When a signal including the correct tone is received, the transceiver emits beep tones for 30 sec. and flashes " (••) . "
- 4) Push [PTT] or the selected band switch [H MAIN] or [R MAIN] to stop the beeps and flashing.
 - Tone squelch is automatically selected.

• Calling a specific station (Ham band only)

To call a station, transmit the correct subaudible tone.

- 1) Program the subaudible tone frequency in SET mode.
 - See p. 32 for programming details.
- 2) Push [ⓅT/P.B/T SQL] 3 times to illuminate "T SQL."
 - "T" indication can be used only for calling (no tone squelch operation after calling) with a pocket beep.
- 3) Push and hold [PTT] for at least 1 sec.

■ Tone squelch operation

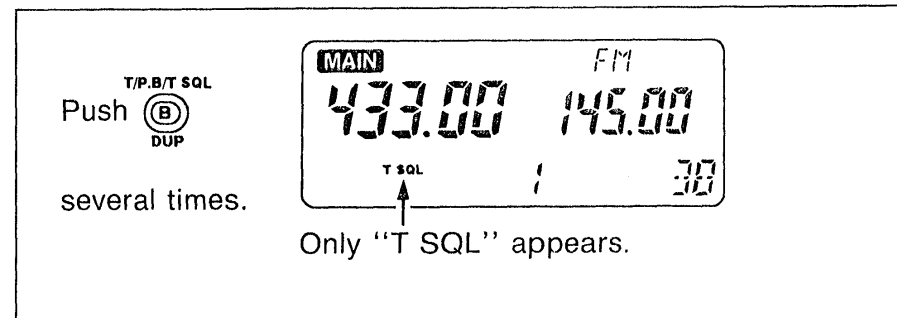

- 1) Program the subaudible tone frequency in SET mode.
 - See p. 32 for programming details.
- 2) Push [ⓅT/P.B/T SQL] several times until "T SQL" appears on the function display.
- 3) When the received signal includes the correct tone, the squelch opens and the signal can be heard.
 - When the received signal includes an incorrect tone, the squelch does not open. Only the green indicator lights up.
 - To open the squelch manually, push and hold [MONI].
- 4) Operate the transceiver in the normal way (push [PTT] to transmit; release [PTT] to receive).
- 5) To cancel tone squelch, push [ⓅT/P.B/T SQL] several times until "T" or "T SQL" disappears from the function display.

19 TROUBLESHOOTING

PROBLEM	POSSIBLE CAUSE	SOLUTION	REF.
<ul style="list-style-type: none"> No power comes on. 	<ul style="list-style-type: none"> The battery pack is empty. Poor plug connection of the external DC power cable. 	<ul style="list-style-type: none"> Charge the battery pack or place new dry cell batteries in the battery case. Check the connector or remove the cable. 	p. 11
<ul style="list-style-type: none"> Power cannot be turned OFF. 	<ul style="list-style-type: none"> The battery pack became empty during operation. 	<ul style="list-style-type: none"> Charge the battery pack or place new dry cell batteries in the battery case, then turn the power OFF. 	p. 11
<ul style="list-style-type: none"> Power is turned OFF uncontrollably 	<ul style="list-style-type: none"> The auto power-off function is activated. 	<ul style="list-style-type: none"> While pushing [F], push [ⓐ AO] and then rotate the main dial to turn the function OFF. 	p. 47
<ul style="list-style-type: none"> No sound comes from the speaker. 	<ul style="list-style-type: none"> A [SQL] control is turned too far clockwise. An external speaker or earphone is connected. Pager or code squelch is activated. 	<ul style="list-style-type: none"> Rotate the [SQL] control counterclockwise. Unplug the speaker or earphone. Push [ⓒ PGR/C SQL] several times to turn the function OFF. 	p. 3 pgs. 53, 55
<ul style="list-style-type: none"> Transmitting is impossible. 	<ul style="list-style-type: none"> The PTT lock function is activated. The receiver band is selected. 	<ul style="list-style-type: none"> While pushing [F], push [ⓐ P.L] to cancel the function. Push [H MAIN] to select the ham band. 	p. 22 p. 3
<ul style="list-style-type: none"> Frequency cannot be set. 	<ul style="list-style-type: none"> The lock function is activated. The MEMORY mode or CALL CHANNEL is selected. 	<ul style="list-style-type: none"> While pushing [F], push [Ⓢ LOCK] to turn OFF the lock function. Push [ⓑ V/M] once or twice to select VFO mode. 	p. 17 p. 17
<ul style="list-style-type: none"> Scan cannot be activated. 	<ul style="list-style-type: none"> The CALL CHANNEL is selected. Priority watch is activated. The squelch of the selected band is open. 	<ul style="list-style-type: none"> Push [Ⓓ CALL] to exit CALL CHANNEL. Push [ⓓ PRIO] to deactivate the priority watch. Rotate the [SQL] control clockwise. 	p. 23 p. 39 p. 34
<ul style="list-style-type: none"> Clock and timers cannot be programmed. 	<ul style="list-style-type: none"> The receiver band is selected. 	<ul style="list-style-type: none"> Push [H MAIN] to select the ham band. 	p. 40

GENERAL

- Current drain :

CONDITION		BAND		
		HAM	RECEIVER	
Transmit (13.5 V)	High power	1.6 A	—	
	Low power 1	700 mA	—	
Receive (12.5 V)	One band operation	Power saved	20 mA* ¹	
		Rated audio output	20 mA* ¹	
	Dual band operation	Power saved	40 mA* ¹	
		Rated audio output	250 mA	

*¹Average value.

- Usable battery pack : BP-81 ~ BP-85 or BP-90
- External DC power supply : 6 ~ 16 V DC (negative ground)
- Usable temperature range : -10°C ~ +60°C; +14°F ~ +140°F
- Dimensions and weight (Projections not included.) :

VERSION	DIMENSIONS	WEIGHT	BATTERY
IC-4SRA (U.S.A.)	54(W) × 170(H) × 36(D) mm 2.1(W) × 6.7(H) × 1.4(D) in	500 g 1.1 lb	BP-84
IC-4SRA (Australia) IC-4SRE	54(W) × 135(H) × 36(D) mm 2.1(W) × 5.3(H) × 1.4(D) in	385 g 13.6 oz	BP-82
IC-4SRA (Asia)	54(W) × 154(H) × 36(D) mm 2.1(W) × 6.1(H) × 1.4(D) in	430 g* ² 15.2 oz* ²	BP-90

*²Weight includes 6 dry cell batteries.

HAM BAND General

- Frequency coverage : U.S.A. version 440 ~ 450 MHz
Other versions 430 ~ 440 MHz
- Mode : FM
- Frequency stability : ±5 ppm (0°C ~ +50°C; +32°F ~ +122°F)
- Tuning steps : 5, 10, 12.5, 15, 20, 25, 30 and 50 kHz; and 100 kHz, 1 MHz for dial select steps.
- Number of memory channels: 33 (Scan edge and call channels included.)
- Antenna impedance : 50 Ω (nominal)

Transmitter

- Output power (at 13.5 V) : 5 W, 3.5 W, 1.5 W and 500 mW selectable
- Max. frequency deviation : ±5 kHz
- Spurious emissions : Less than -60 dB

Receiver

- Receive system : Double-conversion superheterodyne
- Intermediate frequencies : 1st 35.8 MHz 2nd 455 kHz
- Sensitivity : Less than 0.16 μV for 12 dB SINAD
- Squelch sensitivity : Less than 0.18 μV at threshold
- Selectivity : More than 15 kHz/-6 dB
Less than 30 kHz/-60 dB
- Spurious response rejection : More than 60 dB
- Audio output power : 180 mW at 10% distortion with an 8 Ω load.
- Audio output impedance : 8 Ω

RECEIVER BAND

- Frequency coverage :

VERSION	FREQUENCY COVERAGE
IC-4SRE (Germany)	28 ~ 29.7 MHz, 144 ~ 146 MHz 430 ~ 440 MHz
IC-4SRE (France)	25 ~ 87.5 MHz, 108 ~ 950 MHz
IC-4SRE (Others) IC-4SRA	25 ~ 950 MHz

Guaranteed frequency coverage is 50 ~ 905 MHz.

- Mode : AM, FM and WFM
- Tuning steps : 5*³, 10, 12.5, 15*³, 20, 25, 30 and 50 kHz; and 100 kHz, 1 MHz, 10 MHz for dial select steps. *³Not available in the range between 267.8 ~ 950 MHz
- Number of memory channels: 63 (Scan edge and call channels included.)
- Receive system : Triple-conversion superheterodyne
- Intermediate frequencies : 1st 266.7 MHz 2nd 10.7 MHz 3rd 455 kHz
- Sensitivity*⁴ (Typical) : AM 1.8 μV for 10 dB S/N
FM 0.56 μV for 12 dB SINAD
WFM 1.8 μV for 12 dB SINAD
- Audio output power : 180 mW at 10% distortion with an 8 Ω load.
- Audio output impedance : 8 Ω

All stated specifications are subject to change without notice or obligation.

